

**Portable machines
cutting, welding and gas equipment**

 **KOIKE**

Your cutting needs – achieved.



KOIKE – the spirit of cutting

in 1918, Koike was established in Tokyo, Japan. Since then, we played a major role in the development and manufacturing of high-quality metal cutting machine tools of various types, gas apparatus, welding equipment and positioners. Koike can rely on more than 100 years of experience in the industry and we serve many leading industrial customers which include steel service centers, shipyards, heavy equipment manufacturers, steel construction, power plants, offshore and other metal industries.

Koike is the world's leading manufacturer of the most extensive cutting product line for oxy-fuel, plasma and laser cutting machines. Koike combines Japanese technology and implemented knowledge with experience from our local markets and customers' needs to provide our superior technology in handheld torches and portable cutting machines up to complex CNC controlled cutting machines.

Table of contents

Cutting and Welding	Page 4 - 9	IK-12 NEXT
Cutting	Page 10 - 11	Handy Auto Series
	Page 12 - 13	IK-12 Beetle
	Page 14 - 15	IK-93T HAWK
	Page 16 - 19	IK-72T
	Page 20 - 21	Picle-1
	Page 22 - 23	Auto Picle-S
	Page 24 - 25	KHC-600D
	Page 26 - 27	Mini Mantis II
Welding	Page 28 - 33	Wel-Handy Multi NEXT
	Page 34 - 37	Wel-Handy Mini Strong
	Page 38 - 41	IK-72W Series
Couplings, Torches and Nozzles	Page 42 - 45	Apollo Global Coupling
	Page 46 - 49	Hand Torches
	Page 50 - 55	Koike Cutting Nozzles

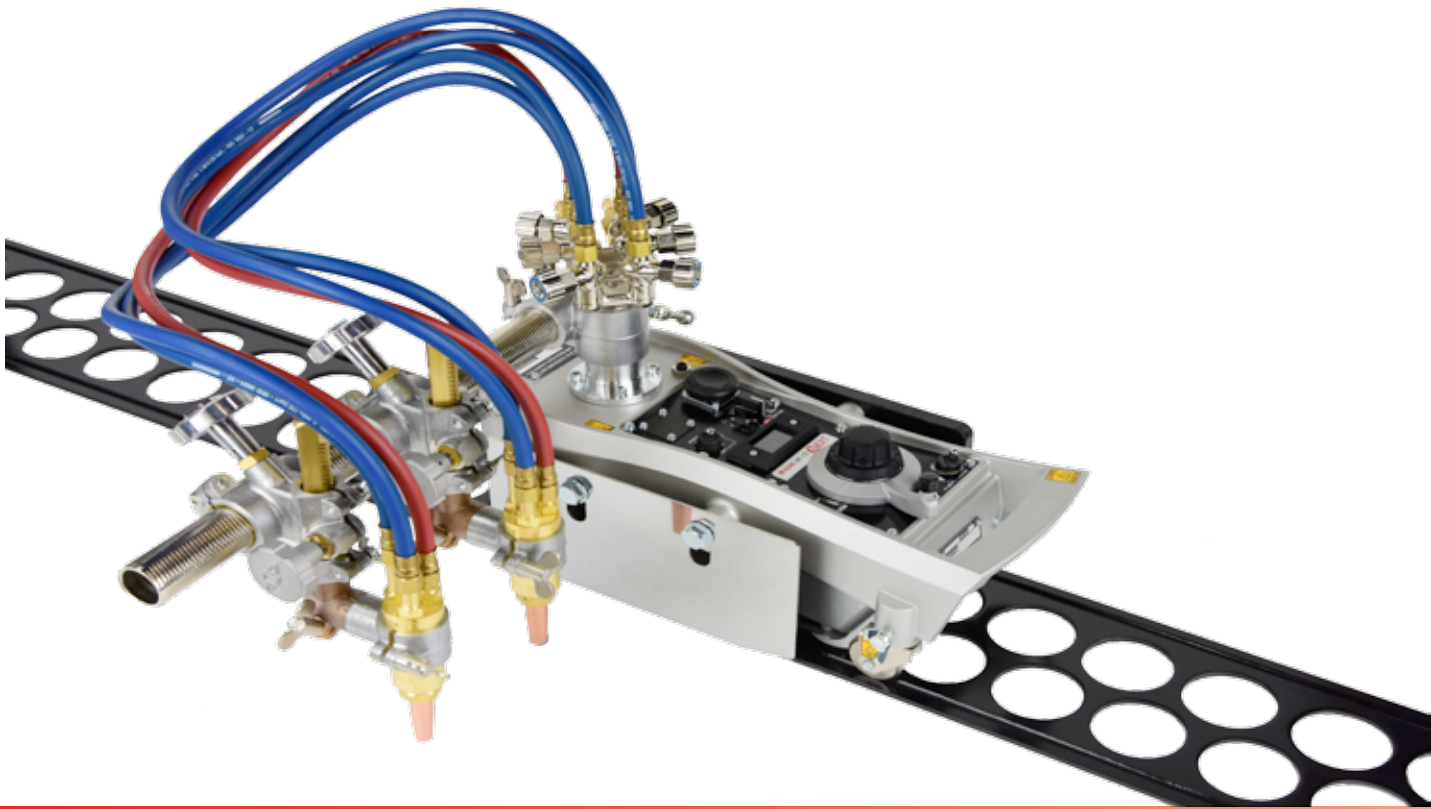

IK-12 NEXT

The Portable Multi-purpose Carriage

Cutting oxy-fuel and plasma, welding

Features and Benefits

- **Maximum reliability in most heavy-duty environment**
Not affected by intense heat and fluctuating voltage, the maximum driving mechanism ensures steady traveling.
- **PWM Drive System**
Ensures stable and accurate speed control, achieved with encoder motor and digital speed indicator, which provides the famous sharp, fine cuts.
- **Choice of accessory and options**
Features wide variety of options that makes the machine suitable to achieve various cutting needs.
- **Selectable torch set and rails**
Each torch set is specially designed for the purpose, ensuring the maximum results.
- **Versatility**
Ready for oxy-fuel cutting, plasma cutting or welding.

The IK-12 NEXT is the successor of the IK-12 Max3, which has been highly rated among the portable oxy-fuel cutting machines. Body structure is systematized to apply to different types of work and meet the needs of oxy-fuel and plasma cutting and automatic welding. Each component is functionally worked out as an independent unit, selection and assortment are at the customers disposal to create the system needed for the requirement. Enjoy the maximum efficiency, versatility and productivity with the IK-12 NEXT.



Carriage

The Original.

Since 1951, when the first model was released in Japan, the Koike IK-12 series have been serving professionals who demand the highest quality in plate cutting.

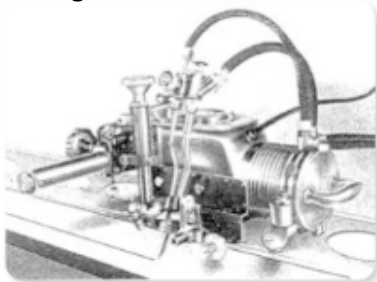

The first generation,
Japan, 1951

Today, the state-of-the-art 7th generation, the IK-12 NEXT has an increased stable and more accurate speed control system due to the encoder motor and electronics. The system can easily be adjusted with the dial knob and values are displayed in a digital scale. The speed parameters can be adjusted over a wide range (40 - 2400mm/min). The "CREEP MODE" (patent pending) is a welcome function to add user control at start/end point of thick plate cutting. The advanced design, accurate constant speed, wide range of input voltage, contributes to an extremely reliable and multi-functional carriage.

Overview of the unit

- It offers excellent operability.
- It can travel over a wide speed range, from 40-2400 mm/min. It incorporates a motor equipped with an encoder and the actual speed is displayed on a digital display.
- Three speed settings can be saved by using the speed presetting function.
- Pressing the "Creep" button, instantly switches to slow mode travel to help to prevent uncut material being left at the start and finished ends when cutting thick material.
- The incorporated arc coupling function enables both plasma cutting and arc welding by changing the torch set.
- A weaving control function is incorporated, making it possible to perform weaving welding by installing the optional kit to mount the WU-3R weaving unit, with no need to add an extra control box.
- Torch sets, rails and other accessories of the existing IK-12 MAX3 model can be used without modification.

Torch set

Oxy-fuel cutting torch set (Machine body is sold separately.
Pictures for illustration purpose only)

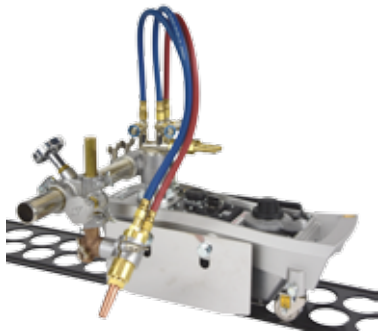

S-100 Torch Set

- Standard 1 torch unit

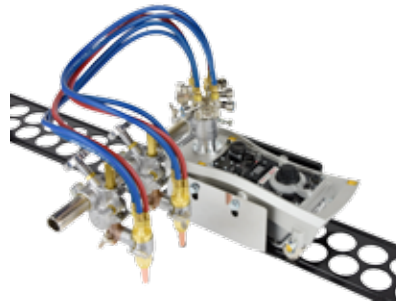

S-200 Torch Set

- Standard 2 torch unit

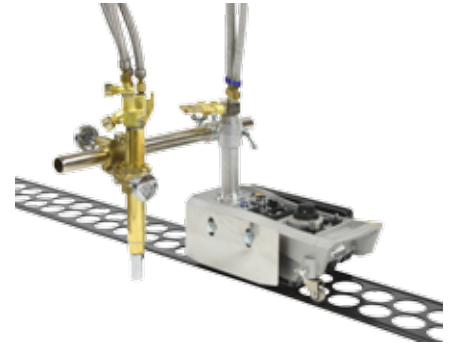

L-100 Torch Set

- Heavy duty torch designed to cut up to 300 mm plate thickness
- Water cooled

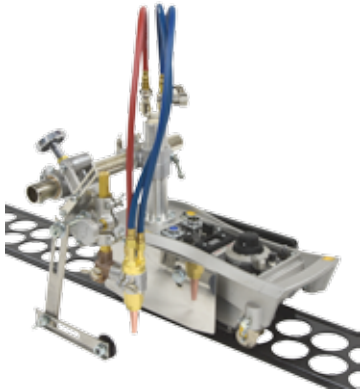

SP-100 Torch Set

- 1 Torch unit with mechanical automatic torch height control

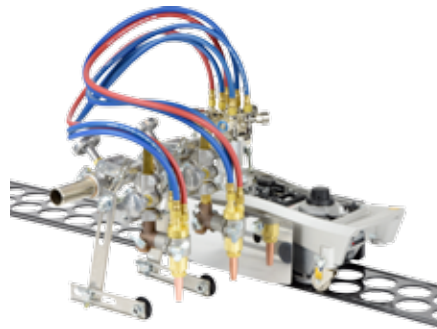

SP-200 Torch Set

- 2 Torch unit with mechanical automatic torch height control on each torch unit

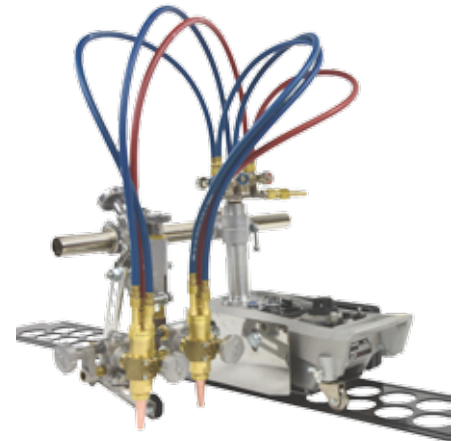

SP-300 Torch Set

- 2 Torch unit with mechanical automatic torch height control
- Maintains angle of 2 torches for accurate Y and X bevel cuts

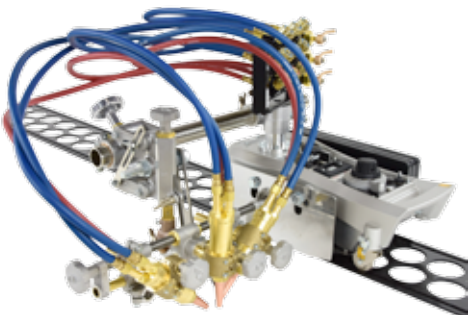

SP-400 Torch Set

- 3 Torch unit with mechanical automatic torch height control
- Maintains angle of 3 torches for accurate Y, X, and K bevel cuts



EPOCH-300/600 Torch Set

- A safe, flashback-free out mixing torch, designed to cut up to 600 mm plate thickness
- Water cooled (EPOCH-600)

Cutting and Welding Machines



S-100 Torch set



S-200 Torch set with long slide bar option



S-100 with long slide bar option



S-100 with long slide bar and bevel attachment option



EPOCH torch set with heavy duty rail



IK-12 NEXT straight welding



IK-12 NEXT straight welding



S-100 Torch set with Long slide bar option



S-100 Torch set with long slide bar and guide roller option

Torch set		S-100	SP-100	S-200	SP-200	SP-300	SP-400	L-100	EPOCH-300	EPOCH-600
Stock #		90036	90038	90037	90039	90040	90041	90042	90043	90046
Max. cutting thickness (1 torch)		150 mm	150 mm	150 mm	150 mm	100 mm	100 mm	300 mm	300 mm	600 mm
Number of torches		1	1	2	2	2	3	1	1	1
Gas mixing	Tip mixing	•	•	•	•	•	•	•	-	-
	Out mixing	-	-	-	-	-	-	-	•	•
Mechanical auto height control		-	•	-	•	•	•	-	-	-
Standard pipe bar length (mm)		350	350	500	500	500	500	500	500	500
Vertical torch stroke (mm)		80	120	80	120	120	120	-	-	-
Cutting type		•	•	•	•	•	•	•	•	•
		•	•	•	•	•	•	•	•	•
		-	-	•	•	-	-	-	-	-
		-	-	•	•	-	-	-	-	-
		-	-	•	•	•	•	-	-	-
		-	-	•	•	•	•	-	-	-
		-	-	-	-	-	•	-	-	-
Optional torch accessories										
Long pipe bar		•	•	•	•	•	•	•	•	•
Long slide bar		•	•	•	•	-	-	-	-	-
Snap valve		•	•	•	•	-	-	-	-	-
Pre-set stop valve		•	•	•	•	-	-	-	-	-

• : possible

Plasma cutting, welding torch set and accessories (Machine body is sold separately.
Pictures for illustration purpose only)

Part numbers

IK-12 NEXT Cutting Set*	Stock #
IK-12 Next carriage	90140

* Select a cutting torch set

IK-12 NEXT Plasma Set*	Stock #
IK-12 Next carriage	90140

Machine connection cable for IK-12 Next 61005388

Plasma holderset IK-12 Next 20511063

* To be used with a plasma system

IK-12 NEXT Welding Straight Set*	Stock #
IK-12 Next carriage	90140

Machine connection cable for IK-12 Next 61005388

Welding Holder set IK-12 Next 20511050

* To be used with a welding system

IK-12 NEXT Welding Weaving Set*	Stock #
IK-12 Next carriage	90140

Machine connection cable for IK-12 Next 61005388

Weaving holder set IK-12 Next 20511064

* To be used with a welding system

Accessories

Accessory	Stock #
IK-12 standard rail 1800 mm	30400
IK-12 heavy duty rail 1800 mm	90044
IK-12 MAX3 circle cutting rail	30410
Circle cutting attachment	30389
Plate edge guide roller	T60038959
Preset stop valve:	
1 Torch	80518
2 Torch	61003543
Snap valve B-type	80512
Torch bevel attachment	ON002
Twin torch attachment	ON001
Rail fixing magnet	D6010
MIG torch holder	61000676

Accessory		Stock #
Long slide bar	145 mm (standard)	30390
	250 mm	30430
	300 mm	30431
	400 mm	30433
	350 mm	30300
Long pipe arm	500 mm	30321
	1000 mm	30425
	1500 mm	30427
	2500 mm	30429
Stand	80 mm (standard)	30204
	105 mm	30378
Flashback arrestor hose set	600 mm hoses	On request
	900 mm hoses	On request

Type and Specification

IK-12 NEXT

Weight (body)	8.5 Kg / 18.74lb
Machine size	432 mm / 17 inch
Machine width	220 mm / 8.66 inch
Max. loaded weight	50 kg / 110.23 lb
Traveling speed	40~2400 mm/min / 1.57~94.49inch/min
Creep speed	40~300 mm/min / 1.57~11.81inch/min
Input power	100~240VAC ±10% / 1.1~0.7A / 50-60Hz
Motor	24VDC motor with an encoder, 23W, 5600rpm
Transmission	Dial accelaration formula, variable speed
Speedometer	Digital display

Scope of delivery

Machine body
Tip support
Hexagon bolt (2 pcs)
Operation manual

Cutting and Welding Machines

Optional accessories



Standard rail 1800 mm

- Extendable 1800 mm rail
- Built of special steel to ensure long life time



Circle cutting rail

- Cutting diameter $\varnothing 40 - 360$ mm (inside); $\varnothing 770 - 1150$ mm (outside)
- Counter weight recommended



Heavy duty rail 1800 mm

- Extendable, robust structured rail that does not bend
- Recommended when cutting thick plate over 150 mm



Circle cutting attachment

- Cutting diameter $\varnothing 400 - 2400$ mm



Long slide bar

- Extends torch up/down stroke, used when cutting from the side of the plate
- Available in different lengths



Plate edge guide roller

- Enables bevel cuts without rail by tracking plate edge
- For straight line cutting only

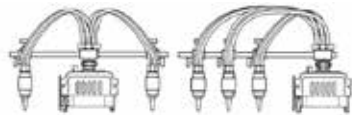

Long pipe arm

- Long pipe arm to enable different torch positioning
- Available in different lengths



Snap valve B-type

- Single action gas on/off
- Increases productivity by eliminating flame adjustments each time after cut



Preset stop valve

- Single action gas on/off
- 2 models; single or two torches



Twin torch attachment

- Enables 2-torch parallel cutting by attaching to a torch
- Torch distance 30 - 300 mm



Torch bevel attachment

- Accurate bevel cutting with angle indicator
- Cuts bevel without tilting the torch



Rail fixing magnet

- Holds the rail onto the place



MIG torch holder

- Simple welding torch holder, clamp diameter
- $\varnothing 16 - 20$ mm



Extended stand

- 105 mm long stand



Handy Auto Plus



Handy Auto

HANDY AUTO SERIES

Portable Motorized Hand Torch

Features and Benefits

- **Motorized oxy-fuel hand torch**
 High quality cuts on horizontal plate, pipe, or on vertical surfaces.
- **All position drives**
 Allows cutting in various position and directions.
- **Quick change attachments**
 Single hand changeover.
- **Light weight**
 Easily operated like a hand torch 2.7 kg (Handy Auto) 3.5 kg.
 (Handy Auto Plus)
- **Auto ignition**
 (Handy Auto Plus)
- **One click gas shutoff**
 (Handy Auto Plus)
- **Flame pre-set valves**
 (Handy Auto Plus)

Two models

Handy Auto

- High quality cutting with hand torch handling
- Modular attachment system
- Tool-free attachment replacement
- Set of basic attachments included*

Handy Auto Plus

- Handy Auto with additional features
- Auto ignition
- One-click gas shutoff
- Flame pre-set valves
- Set of basic attachments included*

* Every kit comes with a basic set of attachments to cut straight, bevel and small circle.

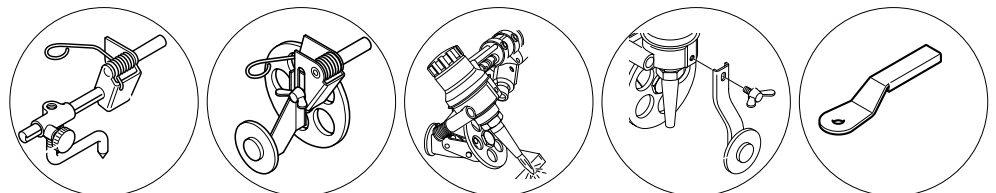

Cutting Machines

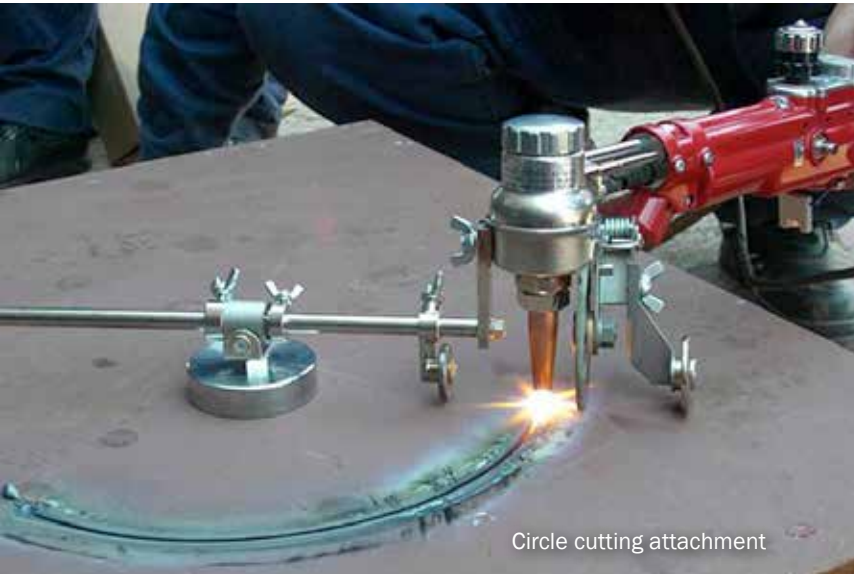

Circle cutting attachment



Straight guide rail

Optional accessories

Accessory	Stock #	Description
Large circle cutting attachment	30106	Cutting diameter 120~500 mm
Straight guide rail 500 mm	30104	Straight cutting guide rail
Battery pack	225.401.101A	
Large circle extension bar 530 mm	30132	Use with large circle cutting attachment to increase cutting diameter to 1000 mm

Types

Model	Stock #
Handy Auto KIT	90005
Handy Auto Plus KIT	90001

Specification

	Handy Auto KIT	Handy Auto Plus KIT
Cutting thickness	5 ~ 30 mm	
Cutting speed	150 ~ 530 mm/min	
Speed control method	Transistor control	
Drive system	Friction drive	
Power source	AC 100 - 240V	
Input power	DC 12V	
Bevel wheel assembly bevel angle	22 ~ 45°	
Small circle attachment cutting diameter	Ø 30 ~ 120 mm	
Machine length	500 mm	525 mm
Weight	2.7 kg	3.5 kg
Auto ignition function	-	•
Pre-set valves	-	•
Flame shut-off function	-	•

• : possible

Scope of delivery

Handy Auto KIT	Handy Auto Plus KIT
	Machine body
	Small circle attachment
	Standard wheel assembly
	Bevelling wheel assembly
	Auxiliary wheel assembly
	Guide lever
	AC adaptor with cable
	Cutting nozzles
	Standard tool set
	Steel carrying case

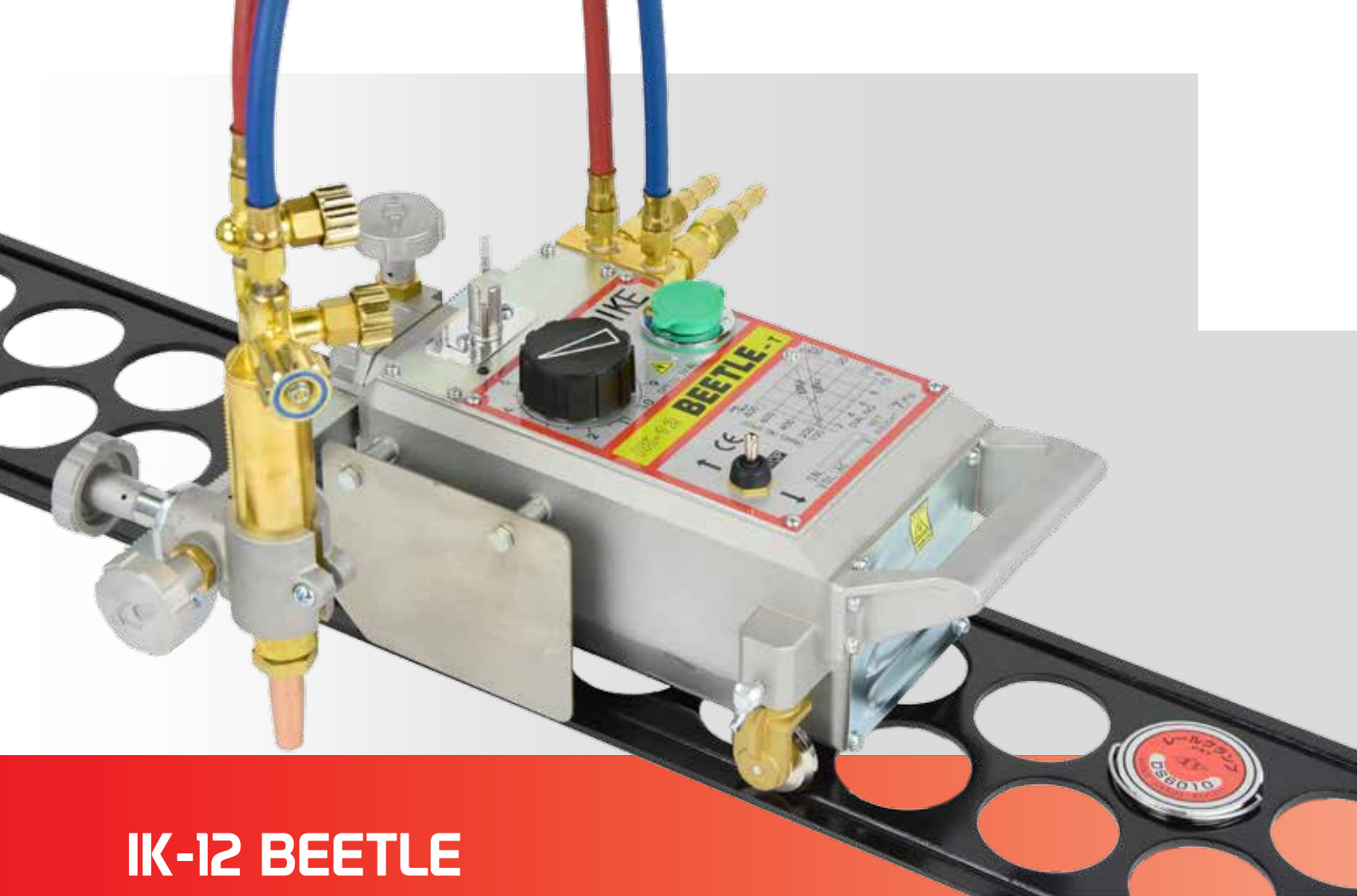

IK-12 BEETLE

Portable Oxy-fuel Cutting Machine

Features and Benefits

- **Multiple use oxy-fuel machine**
Performs high quality straight, circle and bevel cuts. Single model includes 1 torch and 3 cutting nozzles.
- **Single Cone Stepless Drive System**
Maintains constant travel speed even with high temperatures providing stable, trouble-free cutting.
- **Lightweight aluminium body**
At only 9.5 kg, easy to carry and use. Built robust to be a true workhorse.
- **Simple operation**
All functions are controlled by forward / off / reverse switch, clutch lever and speed adjustment knob.
- **Extendable 1800 mm straight rail**
Cut longer parts.

High quality cuts with simple operation

Single Cone Stepless Drive System

Single Cone Stepless Mechanical Drive System equipped on the IK-12 Beetle guarantees a constant and stable movement of the machine, providing sharp, clean cuts. The travel functions (forwards, backwards, stop) are activated only by one operation element. The clutch control assures a trouble-free positioning of the machine. Bevel cutting is achieved by simply adjusting the torch holder at the bottom edge of the plate. A gear rack / bevel drive ensures a precise positioning of the machine torch (Y - and Z-axis).

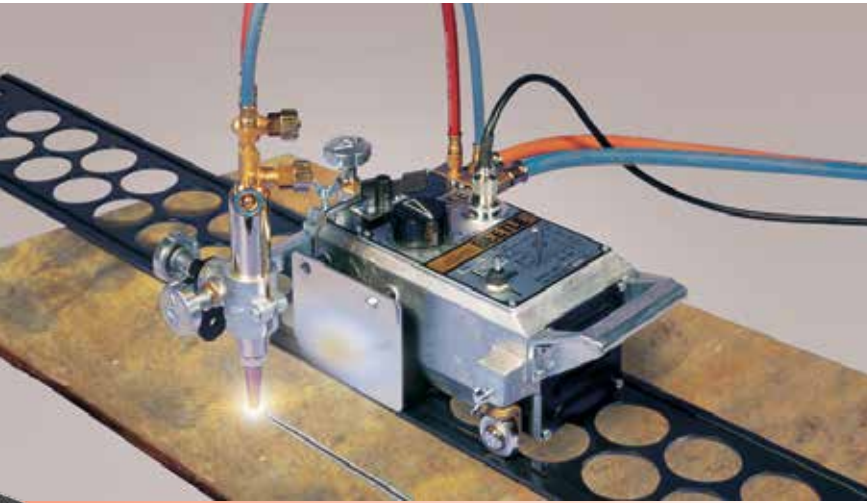

The IK-12 Beetle is an affordable, portable, oxy-fuel cutting machine. It is known around the world as one of the best portable cutting machines in the industry.

Optional accessories

Accessory	Stock #	Description
IK-12 Standard rail 1800 mm	30400	Extendable straight rail
Circle cutting attachment (Beetle)	31858	Cutting diameter: Ø 50 - 2400 mm
Transformer AC230V - 42V	222.002.207	For 42V models
Transformer AC230V - 110V	90100	For 110V models

Specification

	IK-12 Beetle
Cutting thickness	5 - 50 mm
Cutting speed	150 - 800 mm/min
Bevel angle	0 - 45°
Drive system	Single Cone Stepless Drive System
Motor	Induction motor
Input power	AC 220V / 42V
Dimension	L350 x W175 x H140 mm
Weight	9.5 kg

Types

Model	Stock #
IK-12 Beetle 220V	TBCA31005
IK-12 Beetle 42V	90022

Scope of delivery

- Machine body with torch set
- Cutting nozzles (102HC or 106HC, size #0, 1, 2)
- Power cable
- Standard tool set
- Operation manual

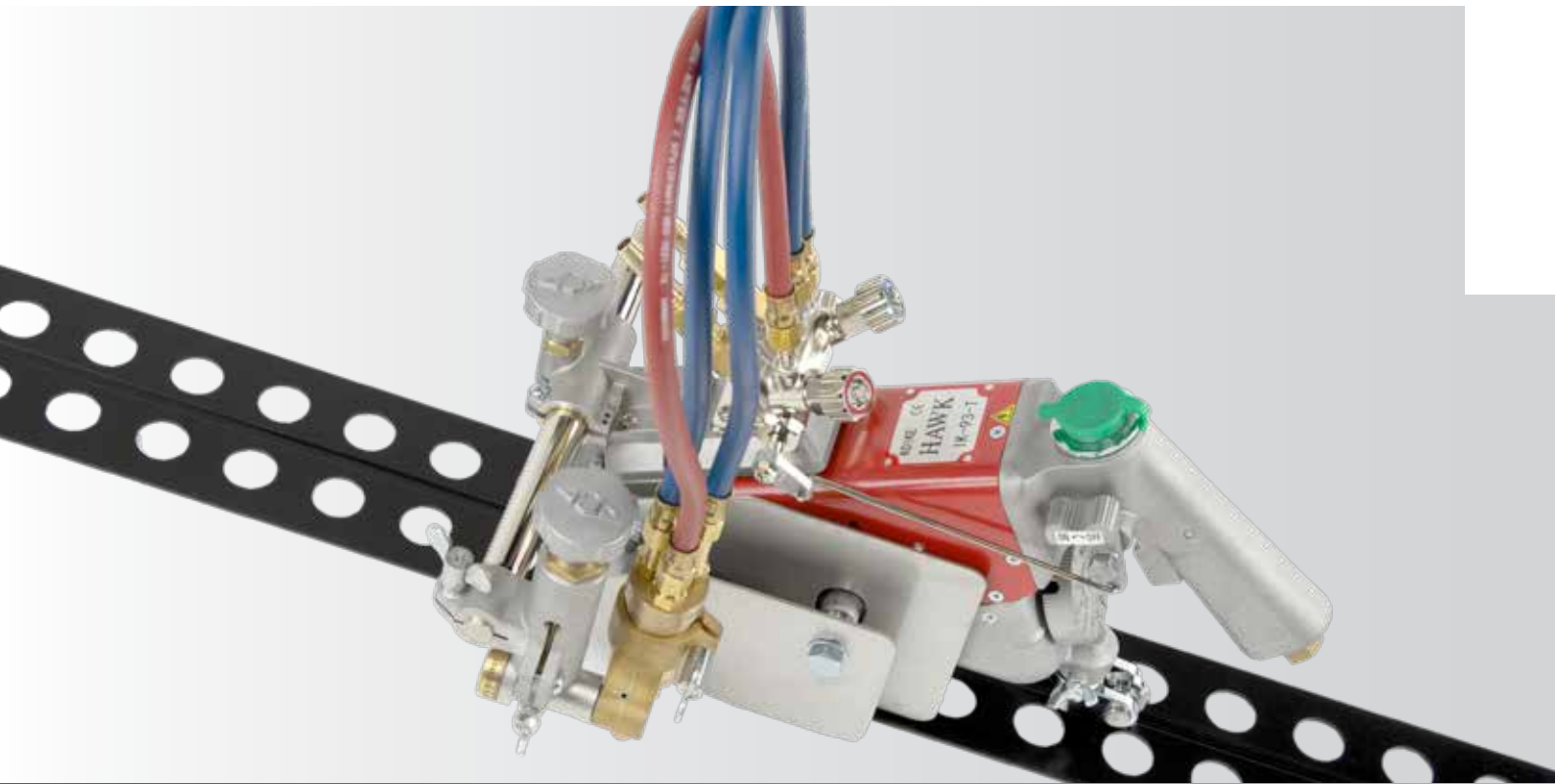

IK-93T HAWK

Mechanized Manual Guiding Cutting Machine

Features and Benefits

■ Pistol shape control grip

Ergonomically designed grip provides comfortable handling of the machine.

■ Centralized control

All functions including cutting oxygen, clutch operation and speed adjustment are located at the grip for ease of operation by one hand.

■ Multiple use oxy-fuel cutting machine

All of straight line, hand guide, circle and plate edge bevel cutting can be done by selecting a suitable option.

■ Compact and lightweight

The machine weighs only 7.5 kg. Together with the slim body and handling grip, the machine can be carried from plate to plate easily.

■ Bevel collar

Torch angle can be set accurately using graduated bevel collar.

High quality multi purpose cutting

Machine handle with centralized controls

IK-93T Hawk is designed with the emphasis on ease of operation with one hand. Its centralized control features a convenient speed adjustment dial, travel switch, clutch and cutting oxygen operation lever. Single wheel drive system provides maximum manoeuvrability, making it easy to change machine travel direction during cutting. The narrow and light-weight IK-93 rail is easily carried and placed. The angle indicator on the torch holder ensures accurate bevel cuts. Together with optional accessories, a wide variety of plate cutting can be achieved with IK-93T Hawk.



Straight cutting with IK-93 rail



Hand guided cutting

The IK-93T Hawk is a portable gas cutting machine developed primarily for the purpose of high quality straight line, hand guided cutting. In addition to featuring high cutting quality, it also demonstrates unprecedented smooth operation and mobility.

Optional accessories

Accessory	Stock #	Description
Extension rail 1800 mm for IK-93	90018	
Circle cutting attachment for IK-93	33353	Cutting diameter: Ø 100 - 1100 m
Plate edge guide roller	T60038959	For bevel cuts along plate edge. Counter weight recommended.
Transformer AC230V - 42V	222.002.207	For 42V models

Specification

	IK-93T Hawk
Cutting thickness	5 - 100 mm
Cutting speed	100 - 1000 mm/min
Bevel angle	0 ~ 45°
Clutch	Trigger type mechanical clutch
Speed control	Control IC
Heat shield	Doubled shield for thermal protection
Input power	AC 220V / AC 42V
Dimension (excl. torch unit)	L380 x W130 x H210 mm
Weight	7.5 kg

Types

Model	Stock #
IK-93T Hawk B - type 42V	TBPJ64009-20
IK-93T Hawk B - type 220V	TBPJ64009-16

Scope of delivery

Machine body with torch set (including slide bar)
Cutting nozzles (102HC or 106HC, size #0, 1, 2)
Power cable
Standard tool set
Operation manual



IK-72T

All Position Oxy-Fuel Cutting Machine

Features and Benefits

- **All position oxy-fuel cutting**
Cuts flat, bended, or twisted steel plates in all positions and directions.
- **Permanent magnet rails**
Secures rail to plate; allows the rail to be used vertically.
- **Selectable rail configuration**
There are 3 unique rail types; the 2D and 3D rails can be connected to each other by use of connector kit, the 1D without.
- **Clutch lever**
Allows quick positioning of machine on rail.
- **Long flange bar option**
For cutting of longer flanges up to 700 mm in diameter.
- **Amazingly lightweight**
Only 4.5 kg and compact; machine can be carried easily anywhere.

High quality cutting in all positions

Flexibility and versatility

The IK-72T is ideal for industries which require out-of-position cutting such as ship-vessel, tank-building and repair. There are three different types of rails available.

- The straight 1D rail made of robust aluminium, allowing straight cutting on flat plate in out-of-place positioning.
- The double-plane 2D rail has a flexible steel strip inside, which makes the rail not to bend in sideways. Ideal for applications which require straight cutting line on bended plate surface such as tank fabrication.
- Triple plane 3D rail is flexible in every direction and suitable for applications which require maximum flexibility.
- All rails are delivered with magnetic holder, enabling cuts in vertical and horizontal position. For maximum magnet efficiency and reduction of rail movement, be sure to clean rusty plate before cutting.



The IK-72T cuts various types of steel shapes including channel, curved plate and angled steel members. Made of an aluminium alloy, the IK-72T is lightweight and easy to handle. A graduated bevel collar is provided for bevelling. Simply adjust the scale to precise bevel angle.

Portability

The IK-72T is designed to maximize portability. Aluminium alloy body together with robust gear system made the machine to be extremely light, yet durable in heavy duty working environment.

- Light weight: 4.5 kg
- Rack and pinion drive system
- Single-action mechanical clutch system allows quick machine positioning along the rail.



Accessories	Rail selections	
Accessory	Stock #	
IK-72T 1D-RAIL 1500 MM	TBPJ64025	
IK-72T 2D-RAIL 1000 MM	90154	
IK-72T 3D-RAIL 1000 MM	TBPJ64026	

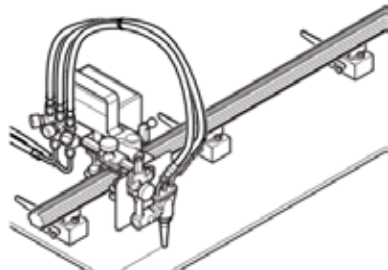

1D Rail 1500 mm

- For flat plate
- Extendable aluminium made straight rail
- Ideal for straight cutting and welding applications
- 4 pcs permanent magnets

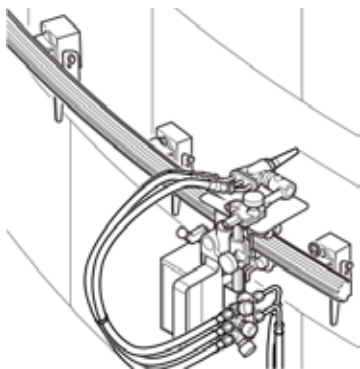
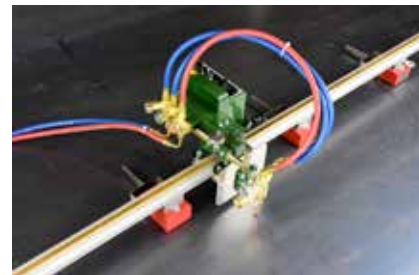

2D Rail 1000 mm

- For bended plane
- Extendable flexible rubber rail with steel plate liner; maximum bending radius 2500 mm
- 5 pcs permanent magnets

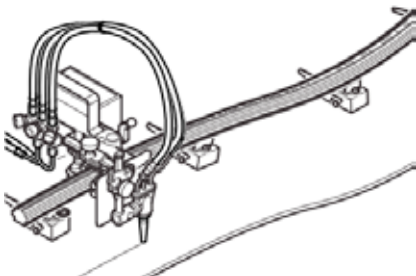

3D Rail 1000 mm

- For bended and twisted planes
- Extendable flexible rubber rail; bends in any direction
- Maximum bending radius 2000 mm
- 5 pcs permanent magnets



Optional accessories

Accessory	Stock #	Description
Rail connector	33107	Parts to connect 1D rail to 2D / 3D rail
Longer vertical bar 350L	31697	Extends torch positioning by 350 mm
Transformer AC230V - 42V	222.002.207	For 42V models
Transformer AC230V - 110V	90100	For 110V models



Transformer

Rail connector
Different rail types can be connected and combined with the rail connector.





Overhead cutting made possible with strong permanent magnets.

Specification	IK-72T
Cutting thickness	5 - 50 mm
Cutting speed	150 - 700 mm
Type of drive	PWM control
Bevel angle	0 ~ 45°
Driving method	Rack and pinion
Input power	AC 110V / AC 42V
Maximum rail bending radius	2D rail: 2500 mm 3D rail: 2000 mm
Dimension	L250 x W300 x H190 mm
Weight	4.5 kg

Types	
Model	Stock #
IK-72T Machine body 42V	90152
IK-72T Machine body 110V	90151

Scope of delivery	
Machine body with torch set	
Cutting nozzles (102HC or 106HC, size #0, 1, 2)	
Power cable	
Standard tool set	
Operation manual	



PICLE-1

Manual Pipe Cutting Machine

Features and Benefits

- **Manual pipe cutting machine**
No power/electricity needed to cut pipe; ideal for field use.
- **Oxy-fuel pipe cutter**
Bevel cuts or straight cuts on steel pipe.
- **Interlocking link chain system**
Swiftly adapts to any pipe diameter.
- **Extremely smooth feed**
Worm gear with low transmission ratio.
- **Accurate bevel angle**
Bevel collar with angle indicator for easy and accurate bevel setting.
- **Lightweight**
At only 8.5 kg, this unit is easy to carry, operate and maintain.
- **Very low maintenance**

Extremely smooth feed

Quality pipe cutting without electrical power

PICLE-1's extremely smooth feed makes the machine handy and easy to operate. The drive chain is comprised of durable, interlocking links that can easily be added or removed for a quick change of pipe diameters.

A graduated bevel collar ensures accurate bevel setting. The control valves for fuel, preheat and cutting oxygen are positioned from heat yet conveniently placed for easy operator use.

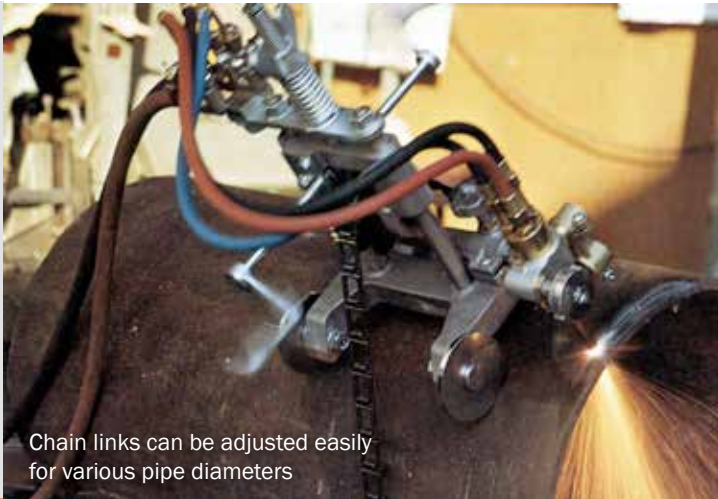

Chain links can be adjusted easily for various pipe diameters

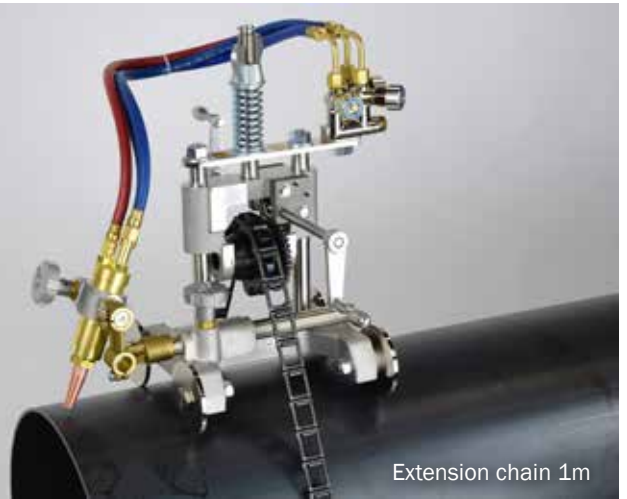

Extension chain 1m

The Picle-1 is a manually operated pipe cutting machine for cutting and bevelling pipes. Equipped with a chain and worm gear drive system with low transmission ratio, leading to an absolutely frictionless feel.

Optional accessories

Accessory	Stock #	Description
Extension chain 1 m	31131	1 m chain links

Specification

	PICLE-1
Cutting thickness	5 - 50 mm
Cutting speed	Manually adjusted
Cutting diameter	Ø 114 ~ 600 mm
Torch up/down stroke	50 mm
Torch lateral stroke	100 mm
Bevel angle	0 ~ 45°
Drive system	Worm gear and chain
Input power	Not required
Dimension	L410 x W210 x H410 mm
Weight	8.5 kg

Types

Model	Stock #
PICLE-1	TBGA35002

Scope of delivery

Machine body with torch set
Chain link (80 pcs. for 600mm pipe diameter)
Cutting nozzles (102HC or 106HC, size #0, 1, 2)
Standard tool set
Operation manual

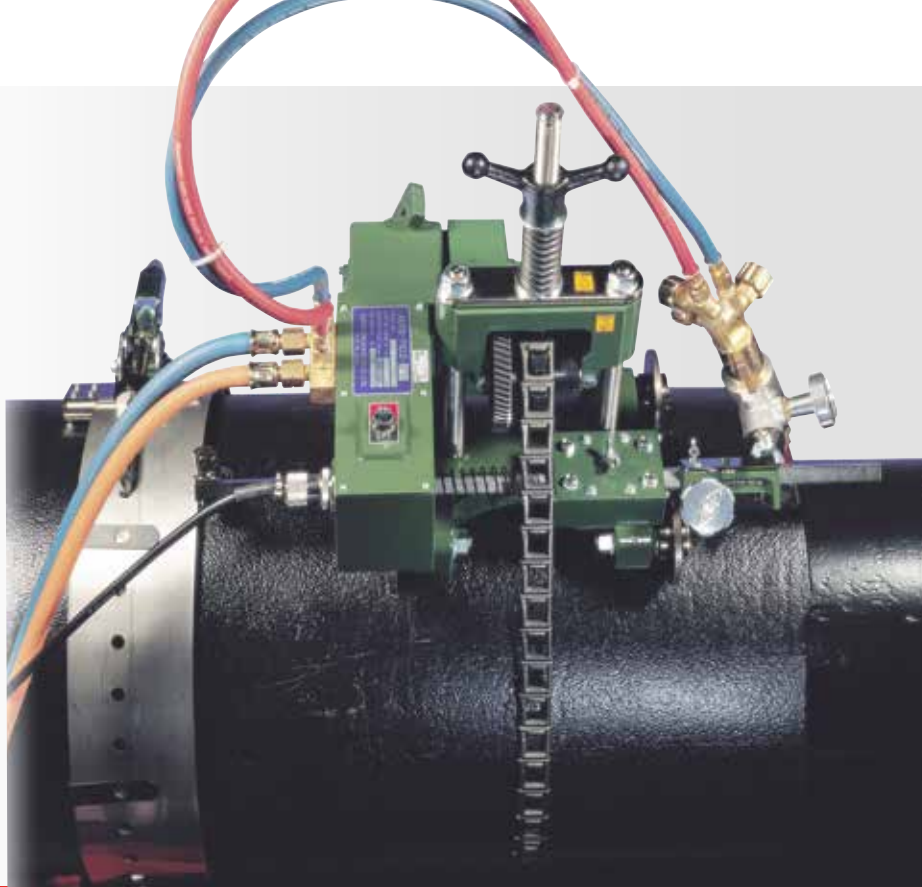

AUTO PICLE-S

Automatic Pipe Cutting Machine

Features and Benefits

- **Guide rail cuts**
Up to 1500 mm diameter pipe accurately; possible to cut pipes in vertical position (up to 500 mm diameter with use of guide rail).
- **Motorized oxy-fuel pipe cutter**
Automatically bevel cuts or straight cuts on steel pipes.
- **Remote Control Pendant**
Easy operation from a distance.
- **Special Fixed Rail Tip Guide System**
The mechanically automatic torch guiding provides a high cutting accuracy.
- **Interlocking link chain system**
Swiftly adapts to any pipe diameter.
- **On/Off drive clutch**
Position and align the machine quickly.

Automatic motorized pipe cutting

Sharp, clean cuts from small to large diameter pipes

The Auto Picle-S is an oxy-fuel pipe cutting machine equipped with a motor and robust gear system. Together with the interlocking transmission chain links, the Auto Picle-S travels smoothly around the pipe in all positions.

Cutting operations are carried out from the handy remote controller.

Travel speed adjustment is easily done during cutting. The slide bar torch system allows flexible torch positioning. When used with the optional guide rail, this system automatically guides the torch along the rail, providing high cutting accuracy for large diameter pipes.



Optional guide rail provides high cutting accuracy, particularly suitable for large pipes. Each guide rail is provided with additional chain links for each maximum pipe diameter.

The Auto Picle-S is a motorized oxy-fuel pipe cutting machine with remote control. The optional guide rail provides high cutting accuracy, particularly suitable for large pipes. Countless professionals from metal fabrication, offshore & pipeline and shipbuilding industries have used Koike pipe cutting machines successfully.

Optional accessories

Accessory	Stock #	Description
Transformer AC230V - 42V	222.002.207	For 42V models
Transformer AC230V - 110V	90100	For 110V models
Extension chain 1 m	31131	1 m chain links

Specification

Auto Picle-S

Cutting thickness	5 - 50 mm
Cutting speed	100 - 700 mm/min
Cutting diameter	Ø 150 - 1500 mm; Guide rail option is recommended above Ø 600 mm
Bevel angle	0 ~ 45°
Drive system	Worm gear and chain
Input power	AC 115V / AC 42V
Dimension	L270 x W230 x H400 mm
Weight	15 kg

Types

Model	Stock #
Auto Picle - S 42V	90117
Auto Picle - S 110V	90116

Scope of delivery

Machine body with torch set (including slide bar)
 Remote controller and cables
 Chain link (80 pcs. for 600mm pipe diameter)
 Cutting nozzles (102HC or 106HC, size #0, 1, 2)
 Standard tool set

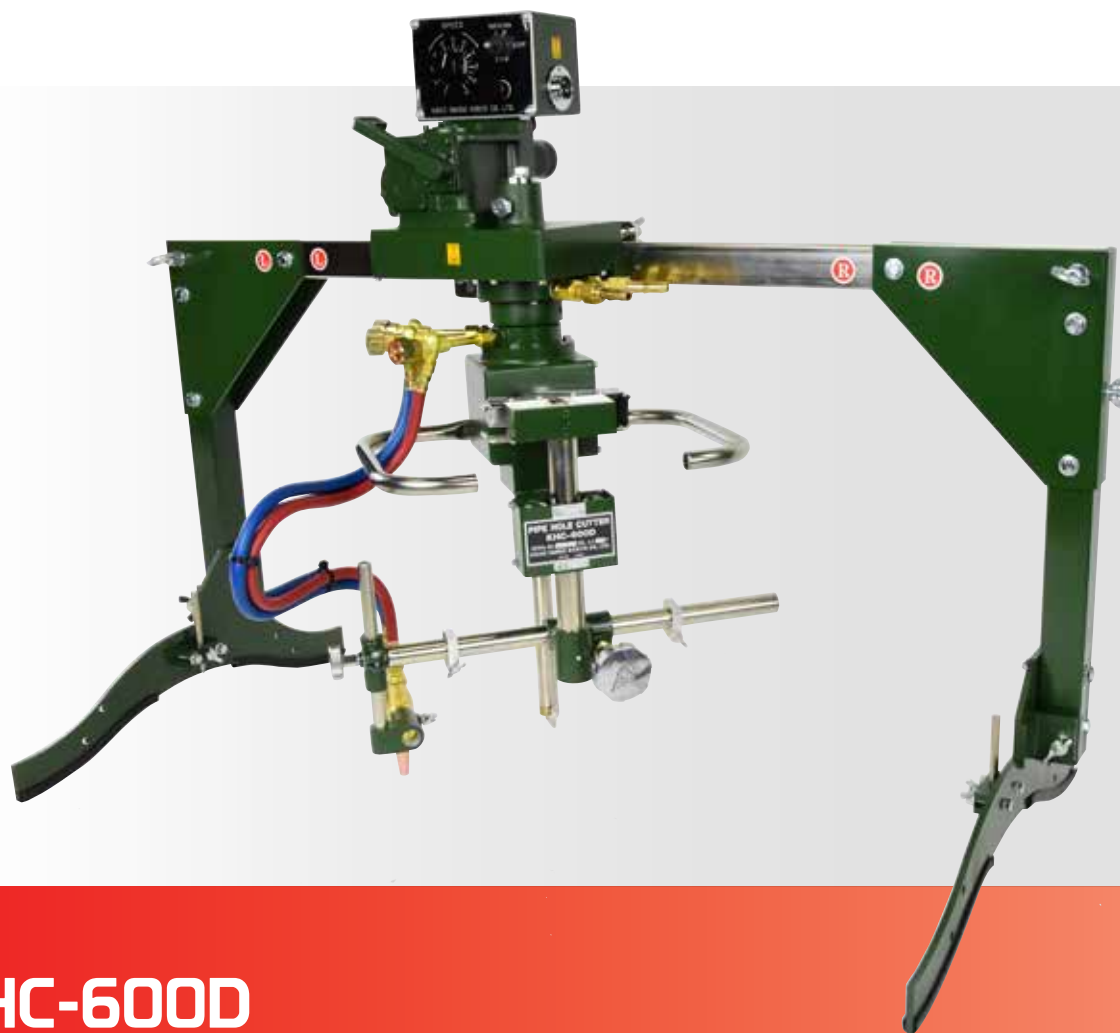

KHC-600D

Pipe Hole Cutting Machine

Features and Benefits

- **Automatic oxy-fuel pipe cutter**
 Automatically bevel cuts or straight cuts holes into pipe.
- **Infinite rotational gas manifold**
 Tangle-free, infinite rotation gas manifold eliminates tension to the torch during cutting, ensuring accurate, sharp & clean cuts.
- **H-lever handle torch**
 Height is automatically maintained to work distance based on trigonometry function of H-lever; very easy setup with just two adjustments.
- **On/Off drive clutch**
 Worm gear with low transmission ratio.
- **Flat plate circle cutting**
 Can be used for circle cutting on flat plate.

T-Joint pipe hole cutting

High quality cuts with easy operation

The distance between the cutting nozzle and the plate is automatically, mechanically maintained, ensuring high quality cuts. Very easy to setup with just two adjustments. Also, an infinite rotation gas manifold with slip coupling is used on the main gas connection, keeping hoses from becoming tangled during operation.

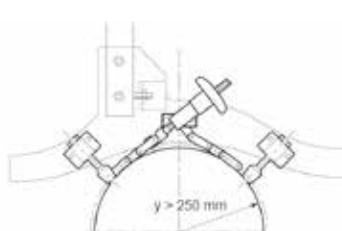

Small diameter pipe fixture

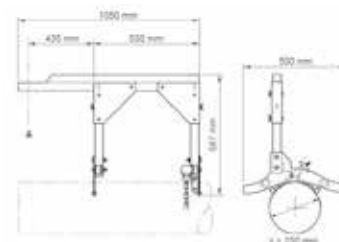

Overhang cutting fixture



The KHC-600D is ideally suited for cutting high precision T- joint circles including any hole that crosses the side of the pipe for piping systems, high pressure vessels and heat exchangers. Developed with KOIKE Advanced Technology, the KHC-600D is a compact design that is light weight and easy to operate. In addition to cutting circles and bevel in flat plate, the machine can cut holes in vessels from the inside or outside.

Optional accessories

Accessory	Stock #	Description
Small diameter pipe fixture	90123	Fixture to small diameter pipes
Overhang cutting fixture	90125	Enables hole cutting near the end of pipe
Transformer AC230V - 42V	222.002.207	For 42V models

Specification

	KHC-600D
Cutting thickness	5 -50 mm
Torch rotation speed	0.12 ~ 1.2 rpm
Cutting diameter	Ø 80 ~ 600 mm
Torch up/down stroke	0 ~ 100 mm
Torch revolving radius	r 40 ~ 300 mm
Bevel angle	0 ~ 45°
Speed control	Control with dial operation
Pipe ratio branch : main	1:2 and above
Input power	AC 42V
Dimension	L1050 x W500 x H760 mm
Weight	26 kg (incl. support leg)

Types

Model	Stock #
KHC-600D 42V	90122

Scope of delivery

Machine body including support leg
Cutting nozzles (102HC or 106HC, size #0, 1, 2)
Power cable
Standard tool set
Operation manual

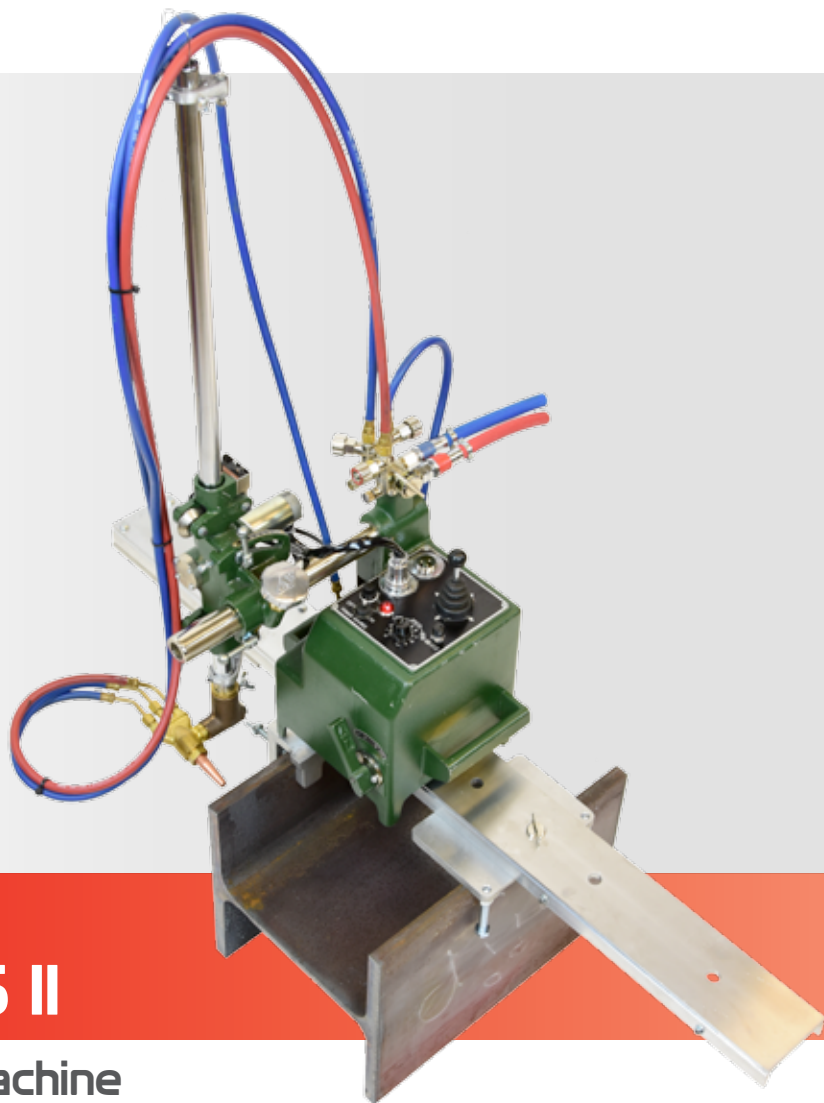

MINI-MANTIS II

H-Beam Cutting Machine

Features and Benefits

- **Three rail types**
Makes web and flange cutting easy and efficient.
- **Adjustable rail and rack bar angle**
Allows diagonal cuts on web and flange.
- **Flame pre-set function**
Set preheat only once; saves time and gas.
- **4-Way jog direction control**
Controls both flange and web cutting with one direction switch.
- **Long flange bar option**
For cutting of longer flanges up to 700 mm.
- **Lightweight and portable**
Easy to carry and use in tight spaces.

Semi-automated H-beam cutting

Ideal for H-beam and I-beam bevelling

The Mini-Mantis II provides straight or angled cuts that are clean and sharp. Two motors drives the torch for both web and flange cutting. There is no need to turn and mark the workpiece.

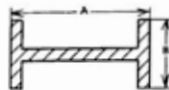

Right angle cutting capacity

- Web cutting ("A" in the diagram)
150 - 600 mm : 600-ST rail
150 - 900 mm : 900-ST rail
900 - 1500 mm : 1500-ST rail

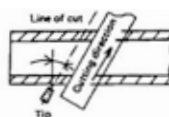

- Flange cutting ("B" in the diagram)
150 - 400 mm : Standard
150 - 700 mm : With optional slide bar 1200L

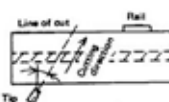

Angled cutting capacity

- 30° maximum for both web and flange cutting



The Mini-Mantis II is a semi-automatic gas cutting unit for rapid and precise cutting of H-beams. The rotatable torch angle allows bevelling cuts on flange and web. The vertical unit can be tilted for cutting flanges in angled directions. KOIKE's quality construction ensures durability and trouble-free operation. The Mini-Mantis II is an economical, efficient and compact gas cutting machine for H-beam steel.

Optional accessories

Accessory	Stock #	Description
600-ST rail	90234	600 mm effective cutting , rail lengths 1100 mm
900-ST rail	90235	900 mm effective cutting , rail lengths 1400 mm
1500-ST rail	90136	1500 mm effective cutting, rail lengths 2100 mm
Slide bar 1200L	32027	700 mm vertical stroke for flange cutting
Transformer AC230V - 110V	90100	For 110V models

Specification

Mini-Mantis II ST Set

Cutting thickness	5 - 30 mm
Cutting speed	100 - 700 mm
Bevel angle	0 ~ 35°
Speed control	Dial operation
Driving method	Web: Friction roller Flange: Rack and Pinion
Input power	AC 110V
Dimension (incl. vertical unit)	L350 x W350 x H880 mm
Weight	15 kg

Types

Model	Stock #
Mini-Mantis II ST 110V Set	90131

Scope of delivery

Machine body
ST-400 Vertical unit with torch unit
Power cable
Standard tool set
Operation manual
Cutting nozzles



WEL-HANDY MULTI NEXT

Heavy-Duty Multi Purpose Mechanized Welding Carriage

Features and Benefits

- **One model with weaving option:**
 Wel-Handy Multi NEXT: Straight/ Tack welding (default).
 Wel-Handy Multi NEXT: Straight/ Tack + Weaving welding (option).
- **Crater fill function**
 Automatically switches to crater amperage and travel backwards to process high quality crater filling.
- **Limit switch function**
 Limit switch has dry-run function, which makes positioning of the carriage possible without lifting. (Patent pending)
- **Encoder drive motor and control**
 Ensures precise speed control during welding.
- **Weaving control only available in combination with weaving set**
 Weaving parameter is adjustable during welding.
 Easy operation with dial control.
- **Straight, tack welding and weaving with the same carriage**
- **Reliability, robustness and durability**

The Wel-Handy Multi NEXT welding carriage is a robust machine designed for heavy duty working environments. The 8.8 kg lightweight aluminium die cast body is easy to handle. The strong traction power from the 50 kg magnet provides stable movement to achieve high quality vertical welds.





All-in-one tack and weaving controller



Multiple Wel-Handy Multi's in simultaneous operation

Durable design, reliable performance

■ Straight and tack welding is standard

The advanced controller is easy to use and provides flexible welding experience with high quality results.

■ Compact and lightweight

L280 x W280 x H250 mm, at weight only 8.8kg.

■ Excellent durability

Maintenance free, single piece aluminium die cast body provides excellent protection against spatter, fume and dust.

■ 50kg Permanent magnet

Ensures strong pulling power during horizontal and vertical welding. The magnet can easily be manually disengaged from the plate by a lever.

■ Low center of gravity

Provides stable performance even when climbing vertically.

■ Durable roller and arm

The guide rollers are made of a single-piece cast aluminium for higher durability. The rollers are protected against spatters.

■ Heat resistant rubber 4-Wheel drive system

Provides strong traction, ensuring high quality welds.

■ Maintenance-friendly by dustproof structure

Mono-design die-cast body casing with stainless steel bottom plate provides complete dustproof structure.

■ 4-Wheel drive system

Provides stable traction and transmits the power to the plate efficiently.

■ High stand off

6 mm Stand off enables crossing over any possible welding beads.

■ Easy setup

No guide rails required, the Wel-Handy Multi NEXT guides itself along the fillet plate.

■ Limit switches

Automatic Shutdown at the end of the weld. Limit switches can be used to adjust machine starting position.

The advanced tack controller

WEL-HANDY MULTI NEXT TACK control - Controllable tack distance

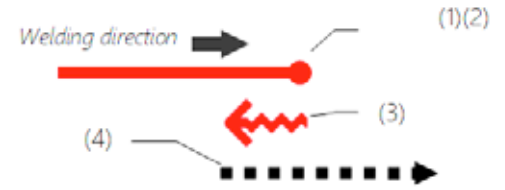
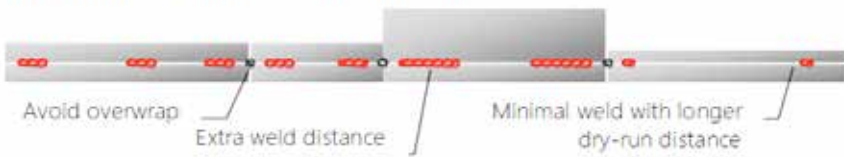

Controllable tack welding distance

- Tack and dry-run distance can be controlled during welding just by simple click on a toggle switch.
- Equipped with an encoder motor, the Wel-Handy Multi NEXT calculates travel distance by counting motor rotations, ensuring accurate distance control.
- All parameter values are shown on the digital display for easier parameter management and repeatability.

Crater filling function (*)

(*) requires welding machine with crater function with matching control.

Automatically switches to crater amperage at the end of each weld for crater fill sequence.

- 1) At the end of each weld, the carriage gives a signal to the welding power source to switch to a crater amperage.
- 2) The carriage stops for a set period of time.
- 3) With crater amperage, carriage welds backwards at a set speed for a set distance.
- 4) After a crater sequence, the carriage dry-runs to the starting point of the next tack weld (in tack welding mode).



WU-3R Weaving Unit and mounting kit (Option: weaving)

This is an option for the Wel-Handy Multi NEXT to perform weaving welding. The weaving function is possible after mounting the weaving unit (WU-3R) together with the mounting kit. Weaving is controlled by a motor with an encoder.

- Weaving speed (*): 400 - 1500 mm/min
 - Weaving widths (*): 0 - 100.0 mm/min
 - Stop timer (left/center/right): 0.0 - 10.0 seconds
- (*) at radius= 100 +mm from the center of rotation control.





Optional accessories

Twin torch option

- 2 Torch fillet welding.
- Upto 500 mm fillet height.
- Lightweight aluminium arms.

Tubular follower guide

- Traverse by vertical guidance of curved plate using bearings on both sides of plate.
- Suitable for welding short pipes onto a plate.

Plate edge guide roller

- Roller adjustable by 50 mm forward/backward.
- Plate need to be 10 mm thickness.

Straight guide rail

- For butt welding in straight line.
- 2m long, 2x magnets included.

Two-point torch holder (curved)

- Secures the torch tightly with 2 clamps.
- Torch compatibility need to be checked.

Torch holder extension bar

- Extends the torch by 140-220mm.
- Suitable for butt welding using guide rail.

Guide roller extension plate

- Extends guide roller by 45 mm.

Clamp lever

- Faster torch angle and position adjustment.

Transformer

- Primary AC 100 - 240V / Secondary DC24V.

Accessories

Accessory	Stock #
Twin torch option	90216
Tubular follower guide	1115-1095-00
Plate edge guide roller	T61004332
Straight guide rail	61002282
Two-point torch holder (curved)	61000865
Torch holder extension bar	T61001223

Accessory	Stock #
Compact submerged arc option	WHMSUB15
Magnet lifting handle	T61001636
Guide roller extension plate	T61002102
Weaving unit WU-3R	20508486
WHM NEXT Weaving Mounting Kit	20505397
Clamp lever	T64000044
Transformer PR 100-240V - SEC 24V 65W	222002256

Application guide

Model Stock #		STRAIGHT + TACK 90224	STRAIGHT + TACK + WEAVING 90224 + Weaving kit
Fillet weld		•	•
Butt weld		Guide rail option	Guide rail option
Tack / Stich weld		•	•
Vertical weld		•	•
Horizontal weld		Guide rail option	Guide rail option
1 Run 2 pass		Tandem torch option	Tandem torch option
Contour weld		Tubular follower guide option	Tubular follower guide option
Pendulum oscillation		-	•
Dual pass		Twin torch option	Twin torch option
Overhanging weld		•	-
Sub-arc		Compact SAW option	Compact SAW option

• : Possible

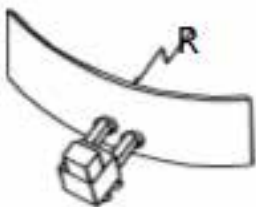

$R > 3000 \text{ mm}$

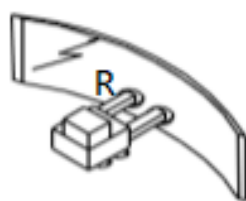

$R > 3000 \text{ mm}$



$\theta = 85 - 110^\circ$

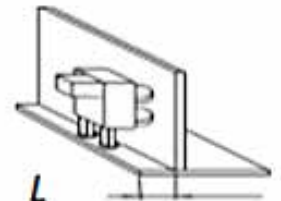

$L > 40 \text{ mm}$

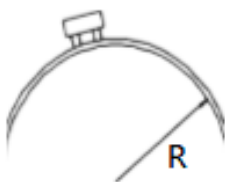

$R > 1500 \text{ mm}$

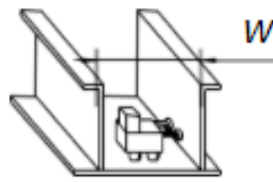

$W > 300 \text{ mm}$

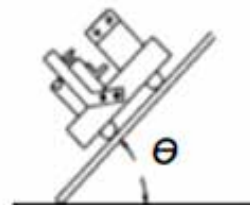

$\theta = 0 - 90^\circ$



$\theta = 0 - 20^\circ$

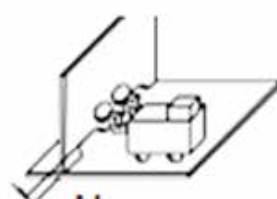

$H < 37 \text{ mm}$

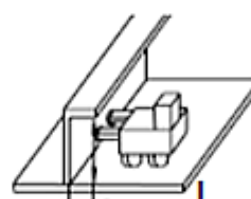

$L > 75 \times 75 \text{ mm}$

Specifications

Model name	Wei-Handy Multi NEXT Tack	Wei-Handy Multi NEXT Weaving Welding
Driving system	4 Wheel driving	
Gap (floor - bottom)	5.5 mm	
Magnet up and down mechanism	Magnet release / light action lever at body side	
Magnet type	Permanent magnet (strong 50 kg)	
Travel speed	50 - 1500 mm/min	
Tracking method	Vertical tracking by guide roller / edge tracking by guide roller	
Applicable posture	Horizontal fillet & inferior fillet	
Start interlocking welding	●	
Automatic stop by limit switch	●	
Arc test	●	
Arc stabilization time (sec)	0 - 10.0	
Crater current correspondence	●	
Tack	●	
	Weaving speed (mm/min)	- 400 - 1500
Weaving	Weaving width (mm)	- 0.0 - 100.0
	Stop time on left, middle, right	- 0.0 - 10.0
Body weight (kg)	8.8	10.8
External dimensions W x D x H (mm)	280 x 280 x 250	310 x 280 x 250
Input power supply	DC 24V	

● : Possible

Types

WHM NEXT Straight/ Tack Set

Description	Stock #
WHM NEXT tack 50kg MG with signal cable	90224
Transformer PR 100-240V-SEC 24V 50W	222.002.256

Types

WHM NEXT Weaving Set

Description	Stock #
WHM NEXT tack 50kg MG with signal cable	90224
WHM NEXT weaving mounting kit	20505397
Weaving unit WU-3R (without holder) for WHM NEXT	20508486
Transformer PR 100-240V-SEC 24V 50W	222.002.256

Scope of delivery

Wei-Handy Multi NEXT

Machine body
Power & signal cable
Allen keys (2 pcs)
Operation manual

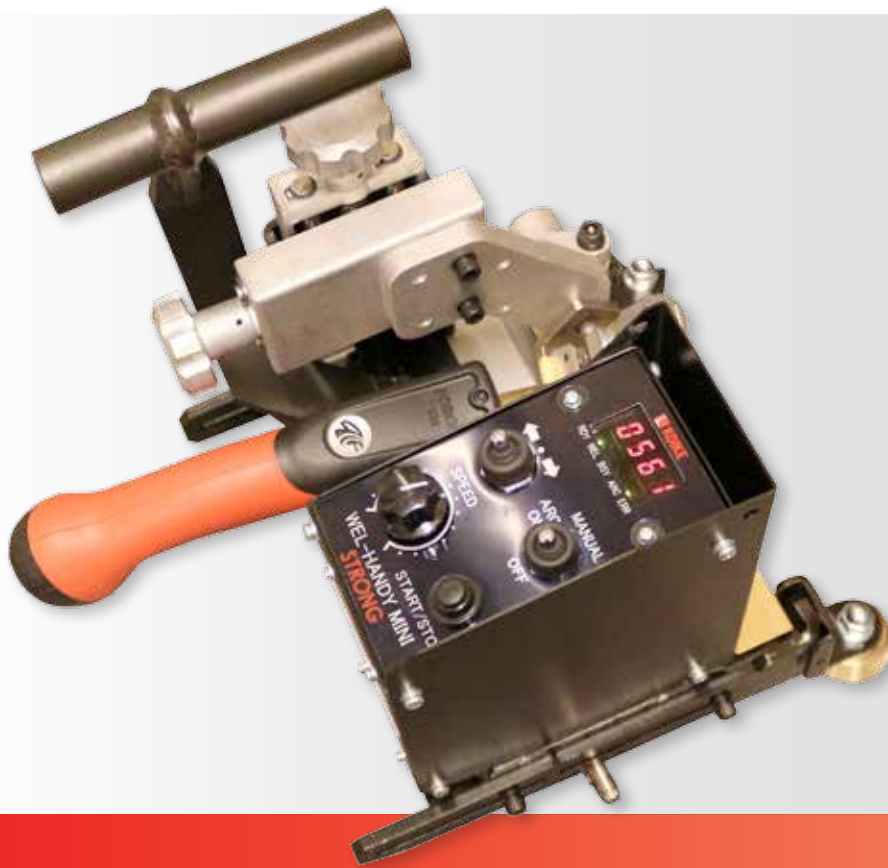

WEL-HANDY MINI STRONG

Compact Welding Carriage for Continuous Welding

Features and Benefits

- Compact, portable design
- Constant speed by motor feedback control
- Strong 35 kg permanent magnet and traction power
- Overload detection function
- Carriage positioning by limit switch
- Widely adjustable guide roller positions
- Lifting handle with magnet detachment mechanism
- Digital display for welding repeatability
- Limit switches on both sides of the machine
- Designed for continuous welding

Advanced control with simple operation

Constant speed control by motor feedback (Servo driver)

The controller on Wel-Handy Mini Strong adopted advanced motor feedback control with servo driver, which maintains constant carriage traveling speed under any load(*). Changes in load, either from weight of welding torch lead or welding positions will not slow down the carriage. Wel-Handy Mini Strong provides constant, high quality welds from the beginning to the end.

Overload detection function

When excessive load is given to the carriage, Wel-Handy Mini Strong stops traveling and stops welding arc automatically.

Increased reliability

Greatly reduces chance of machine components breakage from excessive load.

Minimizes material damage by automatic arc OFF

Avoids further damage to the welding work piece, making it easier to restart.

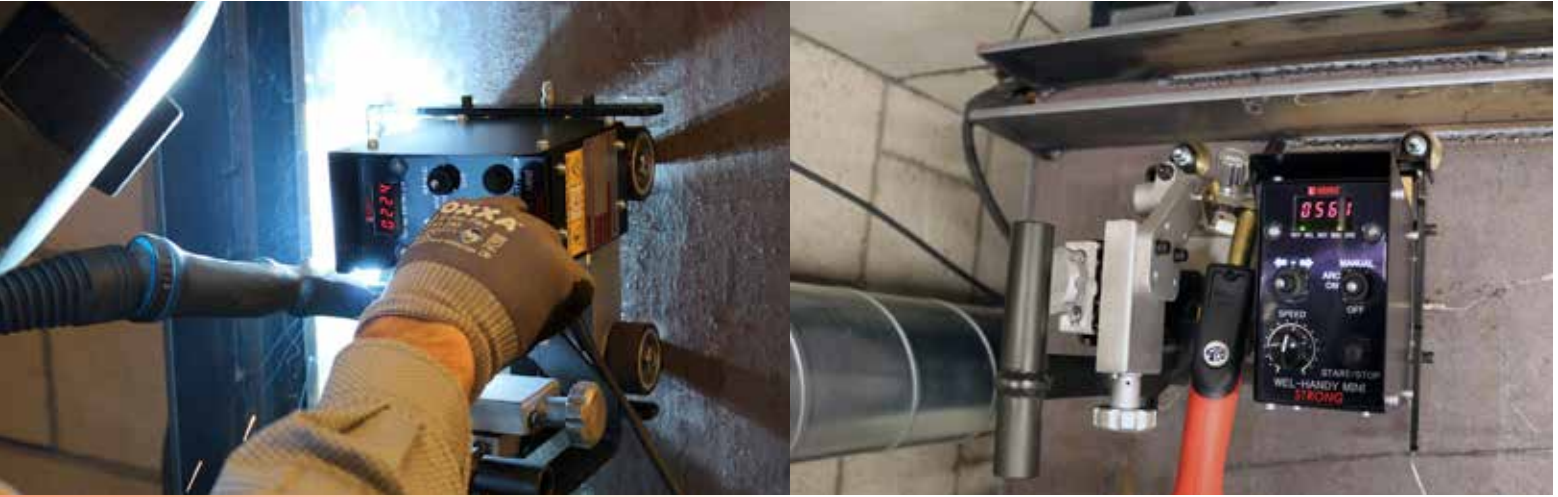

The Wel-Handy Mini Strong is a compact design welding carriage designed to perform horizontal, vertical, and overhang welding. A 35 kg magnet and 16 kg traction power provides reliable performance and quality welds. The machine is easily carried around with the handle with magnet detachment mechanism.

Carriage position adjustment without lifting

Repositions the carriage without the need of lifting. Machine travels when limit switch is being pressed. Precise starting position adjustment can be done in much easier way.

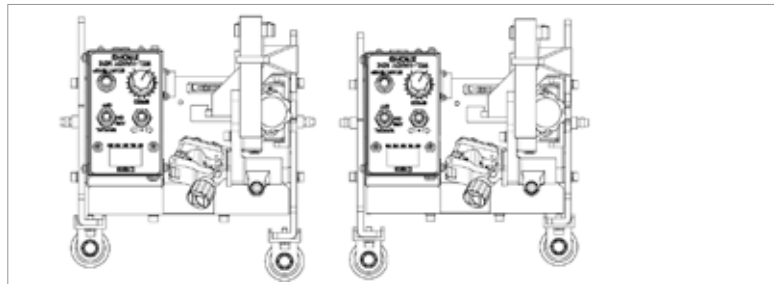

Automatic stop by limit switch

The Wel-Handy Mini Strong is equipped with limit switches on both ends of the machine. When a limit switch is pressed during welding, the machine stops traveling and the arc turns off automatically. Simultaneous welding operation can be done easily with the Wel-Handy Mini Strong.



Mechanical components

Ergonomic design



- **Lifting handle with magnet detachment mechanism**
Pulling the handle detaches the magnet in single action.
- **Large torch adjustment knob**
Allows fine tuning of torch position with welding gloves.
- **Tool-free torch clamp**
Torch can be mounted to the machine without any tools.



Strong permanent magnet power (35 kg)

- Enables the Wel-Handy Mini Strong to weld in vertical and overhang welding positions.

Widely adjustable guide roller positions

- Flexible guide roller height adjustment.
- Guide roller can be flipped over to position on the back.

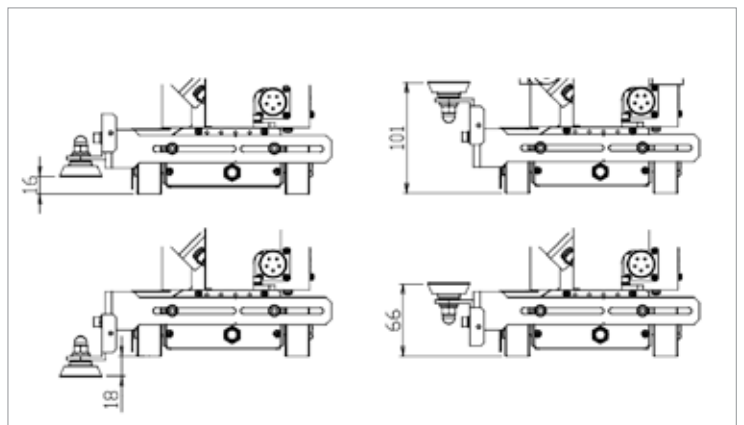

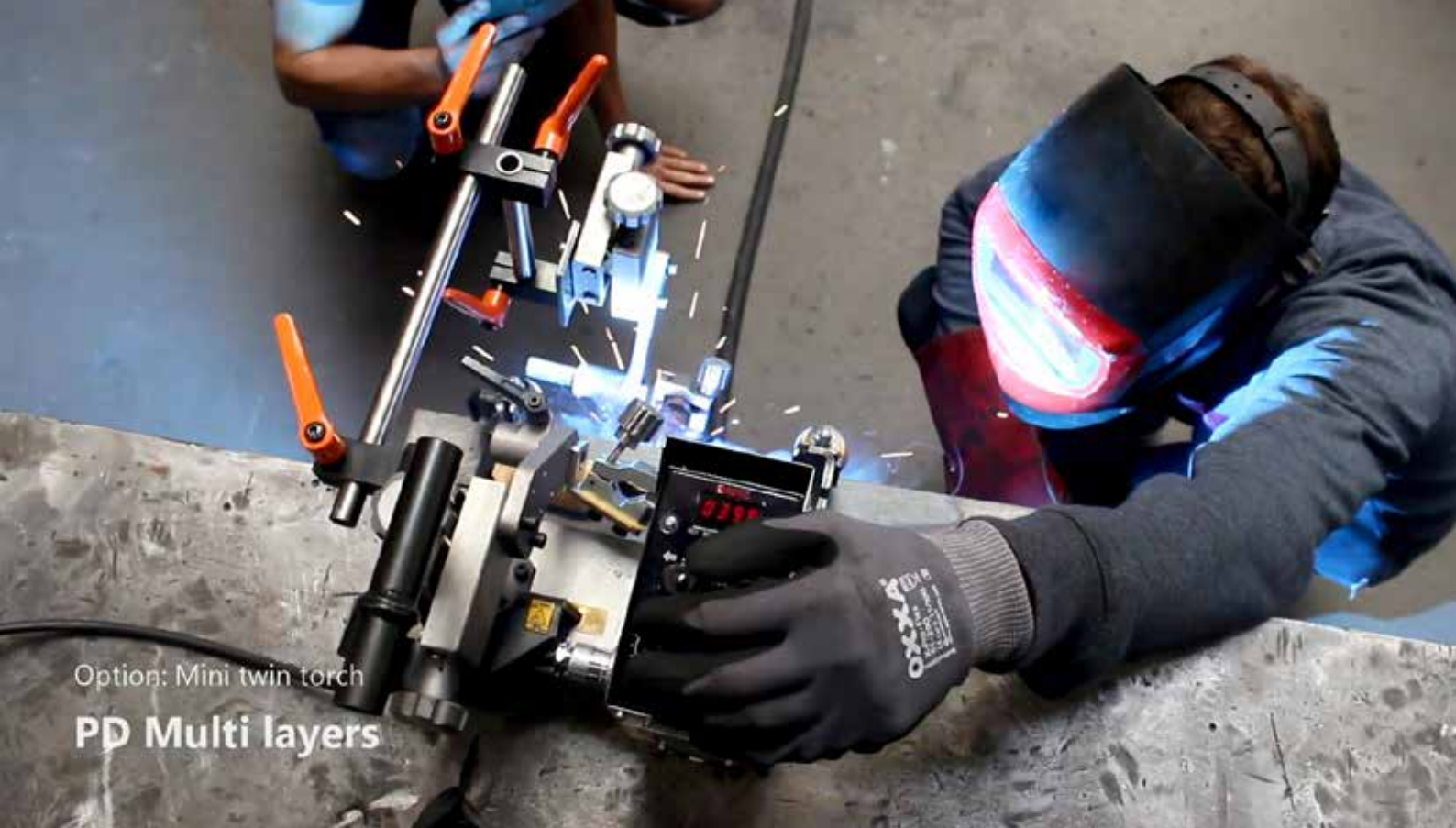

Option: Mini twin torch
PD Multi layers

Optional accessories

Accessory	Stock #	Description
Transformer PR 100-240V-SEC 24V 65W	222.002.256	AC100-240V / DC 24V
Mini twin torch option	90260	For fillet height <160 mm

Specification

Wel-Handy Mini Strong

Machine weight	8.2 kg
Traction force	16 kg
Travel speed	100 - 1000 mm/min
Guiding system	Fillet tracking guide roller
Stand off (plate to base plate)	5.5 mm
Magnet detachment mechanism	Lifting handle integrated
Driving method	4-wheel driving rubber roller (chain transmission)
Magnet type	35 kg permanent magnet
Torch adjustment:	
Torch angle	40 ~ 55°
Up / down	45 mm
Forward / backward	45 mm
Automatic stop functions	Limit switch on each of carriage
Unwelded lengths (start & end total)	Approx. 260 mm
Welding method	Continuous welding
Power & signal cable	Power and signal integrated Y-branch cable
Torch holder diameter	16 ~20 mm
Input power	DC 24V

Types

Model	Stock #
Wel-Handy Mini Strong	90240

Scope of delivery

- Machine body
- Power & signal cable
- Allen keys (2 pcs)
- Operation manual

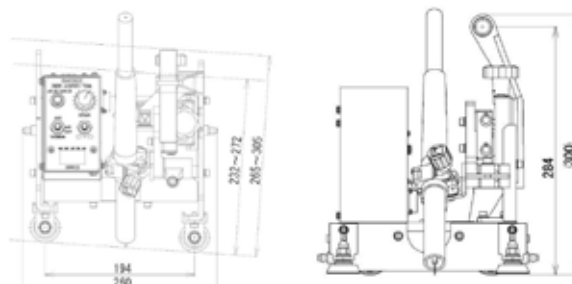



IK-72W SERIES

Rail traveling carriage for all position welding

Features and Benefits

- **Light weight at 5.5 kg (W) / 7.6 kg (WEAVING)**
- **Two models:**
 - IK-72W: Tack welding
 - IK-72W WEAVING: Tack and weaving welding
- **Carriage positioning by limit switch**
- **Advanced tack welding functions**
- **Digitally controlled weaving and tack welding (Weaving model)**
- **Shares the same rail system as the cutting machine IK- 72T; making it possible to weld after cut.**

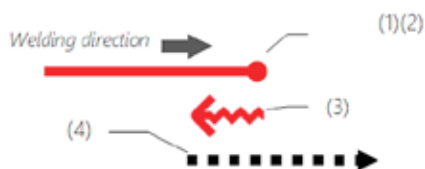

The advanced tack controller

Controllable tack welding distance

- Tack and dry-run distance can be controlled during welding just by simple click on a toggle switch.
- Equipped with an encoder motor, the IK-72T calculates the travel distance by counting motor rotations, ensuring accurate distance control.
- All parameter values are shown on the digital display for easier parameter management and repeatability.

Crater filling function (*)

- (*) Requires welding machine with crater function with matching control.
- Automatically switches to crater amperage at the end of each weld for crater fill sequence.

- 1) At the end of each weld, the carriage gives a signal to the welding power source to switch to the crater amperage.
- 2) Carriage stops for a set period of time.
- 3) With crater amperage, carriage welds backwards at a set speed for a set distance.
- 4) After the crater sequence, the carriage dry-runs to the starting point of the next tack weld (in tack welding mode).



The IK-72W series is used for straight welding in horizontal and vertical positions using 1 dimensional rail and curved and twisted plane welding using 2 and 3 dimensional rails. By using same rail system as the cutting machine IK-72T, cutting and welding can be done with IK-72 system in convenient and lightweight package.

WU-5R Weaving Unit (Option for IK-72W Standard with IK-72W WEAVING model)

Option for IK-72W to perform weaving welding. Includes mounting bracket. Weaving is controlled by encoder motor.

Weaving speed (*) : 400 - 1500 mm/min

Weaving widths:(*) : 0 - 100 mm/min

Stop timer (left/center/right) : 0.0 - 10.0 seconds

(*) at radius=100mm from the center of rotation



Accessories

Rail selections

Accessory	Stock #
IK-72T 1D-RAIL 1500 MM	TBPJ64025
IK-72T 2D-RAIL 1000 MM	90154
IK-72T 3D-RAIL 1000 MM	TBPJ64026

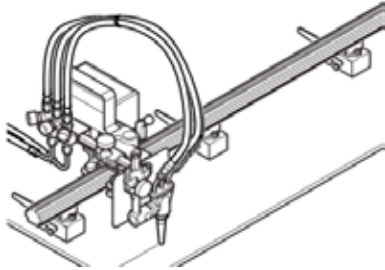

1D Rail 1500 mm

- For flat plate
- Extendable aluminium made straight rail
- Ideal for straight welding applications
- 4 pcs. permanent magnets

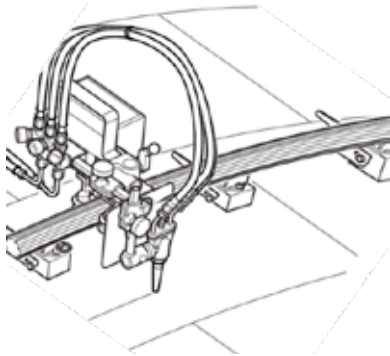
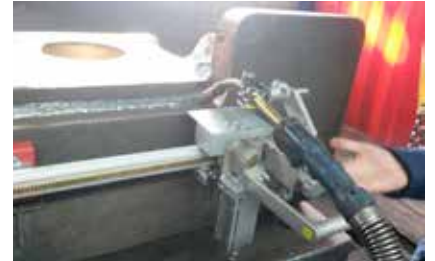

2D Rail 1000 mm

- For bended plane
- Extendable flexible rubber rail with steel plate liner; maximum bending radius 2500 mm
- 5 pcs. permanent magnets
- Upto 30° slope from horizontal position

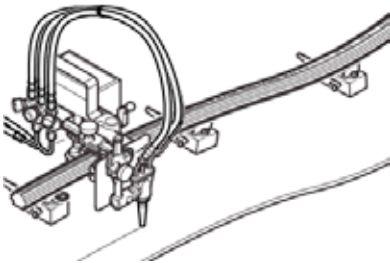

3D Rail 1000 mm

- For bended and twisted planes
- Extendable flexible rubber rail; bends in any directions
- Maximum bending radius 2000 mm
- 5 pcs. permanent magnets
- Upto 30° slope from horizontal position



Optional accessories

Accessory	Stock #	Description
Rail connector	33107	Parts to connect 1D rail to 2D / 3D rail
Transformer PR 100-240V-SEC 24V 65W	222.002.256	Primary 100-240V / Secondary DC 24V
Weaving unit WU-5R	90255	



Specification		IK-72W	IK-72W WEAVING
Machine weight		5.5 kg	7.6 kg
Travel speed		20-600 mm/min	
Guiding method		IK-72 rail system	
Driving method		Rack and pinion	
Torch adjustment:	Up / down	45 mm	
	Forward / backward	45 mm	
Torch holder diameter		16 ~ 20 mm	
Automatic stop function		Limit switch on each end of carriage	
Weaving unit WU-5R		-	Included
Welding method:	Continuous	Yes	Yes
	Tack / stitch	Yes	Yes
	Weaving / Oscillation	Optional	Standard
Power & signal cable		Power and signal cable integrated Y-branch cable (Carriage-branch: 6 m, branch-power: 10 m branch-feeder: 0.5 m)	
Torch holder diameter		16-20 mm	
Position adjustment by limit switch		Yes	
Encoder motor for precise speed control		Yes	
Digital display		Yes	
Crater fill function		Yes	
Input power		DC 24V	

Types	
Model	Stock #
IK-72W	90250
IK-72W Weaving	90251

Scope of delivery
Machine body
Power & signal cable
Rail mounting bracket for limit switch (2pcs)
Allen keys (2pcs)
Operation manual



APOLLO GLOBAL COUPLINGS

Quick-release coupling series

Features and Benefits

- Increase productivity
- High quality
- Easy to use
- Contributes in work-site safety
- Automatic gas supply shutoff
- Double seal packing
- Miss-connection proof
- Designed according to ISO 7289

The Apollo Global couplings are designed to provide a quick set up and removal of cutting and welding equipment. A precisely machined single push system easily connects matching couplings with a click. The safety lock function ensures a secure connection and prevents unintended disconnection during operation. KOIKE Apollo Global couplings are designed according to ISO 7289.



High quality design



■ Brightly colored

For safety, each coupling socket has lock key made of brightly colored resin. Unlike sticker or paint, color is permanent, contributing in safety.

■ Safety lock mechanism

Each socket is equipped with Safety Lock function, which secures the connection and prevents accidental disconnection.

■ Automatic gas supply shutoff

This allows the flow of supply gas only when couplings are connected. Gas supply is automatically shutoff when couplings are disconnected.

■ Double seal packing

The double seal packings between the plug and the socket assures tight sealing.

■ Chrome plated

Durable chrome plating finish provide corrosion resistance and ensures smooth coupling to last.

■ Quality

Designed according to ISO 7289 and produced in Japan under strict quality management.

Technical specifications

■ Maximum working pressure

Oxygen	9.8 bar
Fuel gas	2.0 bar
Inert gas (Welding gas)	9.8 bar

■ Check valve working pressure (Z-type coupling only)

Activation at	0.015 bar
---------------	-----------

■ Durability

Endurance test (by UL)	30,000 cycles
------------------------	---------------

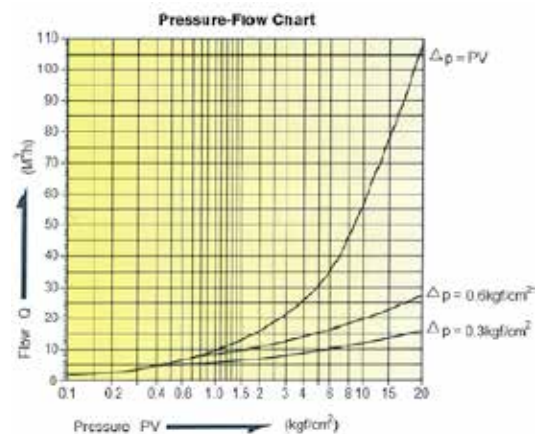

Sample: **Z O P - 1 A S**

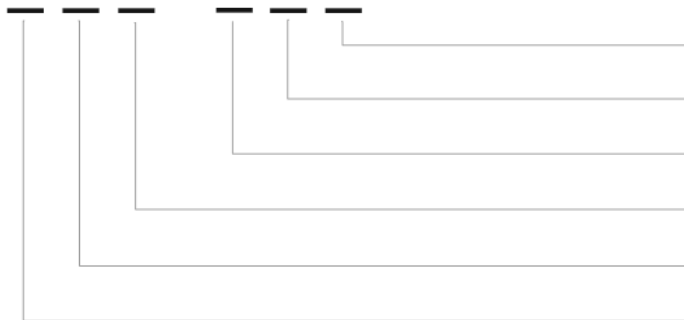

Series

S: "Global" Coupling series

Flashback arrestor

A: Equipped

Gas type

1: Oxygen 2: Fuel gas 3: Inert gas (welding gas)

Connector shape

P : Plug S: Socket

Equipped to

G: Regulator A: Hose O: Machine/Torch

Check valve (back-flow protection)

Z: Equipped

Model: GS



Regulator mount

Model	Connection	Type of gas	Installation	Stock #
GS-1S	G1/4 RH	Oxygen	Regulator	CG2311
	G3/8 RH	Oxygen	Regulator	CG2321
	M16 x 1.5 RH	Oxygen	Regulator	CG2821
	BSPF 3/8" RH	Oxygen	Regulator	CG2621
	US 9/16" -18 UNF RH	Oxygen	Regulator	CG2021
GS-2S	G1/4 LH	Fuel gas	Regulator	CG2333
	G3/8 LH	Fuel gas	Regulator	CG2331
	M16 x 1.5 LH	Fuel gas	Regulator	CG2841
	BSPF 3/8" LH	Fuel gas	Regulator	CG2641
	US 9/16" -18 UNF LH	Fuel gas	Regulator	CG2041
GS-3S	G1/4 RH	Inert gas (Welding gas)	Regulator	CG3031
	G3/8 RH	Inert gas (Welding gas)	Regulator	CG3321
	M16 x 1.5 RH	Inert gas (Welding gas)	Regulator	CG3821
	BSPF 3/8" RH	Inert gas (Welding gas)	Regulator	CG3621
	US 9/16" -18 UNF RH	Inert gas (Welding gas)	Regulator	CG3021

Model: AP / ZAP

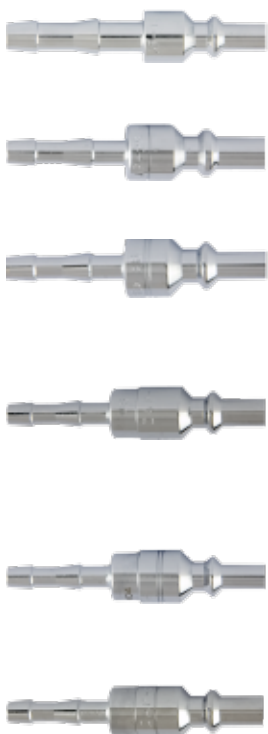

Hose mount, regulator side

Model	Max. hose diameter	Type of gas	Installation	Stock #
AP-1S	6.0 mm	Oxygen	Hose	CG2500
	8.2 mm	Oxygen	Hose	CG2414
	9.2 mm	Oxygen	Hose	CG2424
AP-2S	6.0 mm	Fuel gas	Hose	CG2501
	8.2 mm	Fuel gas	Hose	CG2474
	9.2 mm	Fuel gas	Hose	CG2502
AP-3S	11 mm	Fuel gas	Hose	CG2434
	6.0 mm	Inert gas (Welding gas)	Hose	CG3432
	8.2 mm	Inert gas (Welding gas)	Hose	CG3414
ZAP-1S	9.2 mm	Inert gas (Welding gas)	Hose	CG3424
	6.0 mm	Oxygen	Hose	CG2924
	7.0 mm	Oxygen	Hose	CG2926
ZAP-2S	8.2 mm	Oxygen	Hose	CG2312
	9.2 mm	Oxygen	Hose	CG2322
	11 mm	Oxygen	Hose	CG2922
	6.0 mm	Fuel gas	Hose	CG2944
	7.0 mm	Fuel gas	Hose	CG2946
ZAP-3S	8.2 mm	Fuel gas	Hose	CG2334
	9.2 mm	Fuel gas	Hose	CG2942
	11 mm	Fuel gas	Hose	CG2332
	9.2 mm	Inert gas (Welding gas)	Hose	CG3924
ZAP-3S	8.2 mm	Inert gas (Welding gas)	Hose	CG3312
	9.2 mm	Inert gas (Welding gas)	Hose	CG3322



Model: AS



Hose mount, machine / torch side

Model	Max. hose diameter	Type of gas	Installation	Stock #
AS-1S	6.0 mm	Oxygen	Hose	CG2963
	7.0 mm	Oxygen	Hose	CG2967
	8.2 mm	Oxygen	Hose	CG2341
	9.2 mm	Oxygen	Hose	CG2351
	11 mm	Oxygen	Hose	CG2961
AS-2S	6.0 mm	Fuel gas	Hose	CG2983
	7.0 mm	Fuel gas	Hose	CG2987
	8.2 mm	Fuel gas	Hose	CG2363
	9.2 mm	Fuel gas	Hose	CG2981
	11 mm	Fuel gas	Hose	CG2361
AS-3S	6.0 mm	Inert gas (Welding gas)	Hose	CG3132
	8.2 mm	Inert gas (Welding gas)	Hose	CG3341
	9.2 mm	Inert gas (Welding gas)	Hose	CG3351

Model: ZOP



Machine / torch mount

Model	Max. hose diameter	Type of gas	Installation	Stock #
ZOP-1S	G1/4 RH	Oxygen	Machine / Torch	CG2342
	G3/8 RH	Oxygen	Machine / Torch	CG2352
	M16 x 1.5 RH	Oxygen	Machine / Torch	CG2862
	BSPF 3/8" RH	Oxygen	Machine / Torch	CG2662
	US 9/16" -18 UNF RH	Oxygen	Machine / Torch	CG2062
ZOP-2S	G1/4 LH	Fuel gas	Machine / Torch	CG2364
	G3/8 LH	Fuel gas	Machine / Torch	CG2362
	M16 x 1.5 LH	Fuel gas	Machine / Torch	CG2882
	BSPF 3/8" LH	Fuel gas	Machine / Torch	CG2682
	US 9/16" -18 UNF LH	Fuel gas	Machine / Torch	CG2082
ZOP-3S	G1/4 RH	Inert gas (Welding gas)	Machine / Torch	CG3342
	G3/8 RH	Inert gas (Welding gas)	Machine / Torch	CG3352
	BSPF 3/8" RH	Inert gas (Welding gas)	Machine / Torch	CG3662
	US 9/16" -18 UNF RH	Inert gas (Welding gas)	Machine / Torch	CG3062
ZOP-1AS	G1/4 RH	Oxygen	Machine / Torch	CG2372
	G3/8 RH	Oxygen	Machine / Torch	CG2472
ZOP-2AS	M16 x 1.5 RH	Oxygen	Machine / Torch	-
	G3/8 LH	Fuel gas	Machine / Torch	CG2392
	1/4 RH	Oxygen	Machine / Torch	CG2492



HAND TORCHES

Heavy Duty Gas Cutting Torches

Features and Benefits

- Tip mixing system
- Precisely balanced
- Heavy ribbed round handle
- Internal tip nut
- Easy grip gas valves

Each cutting torch is built to the highest standards, then stringently tested to ensure a safe, long life operation. Designed for the professional for use in industries such as metal fabrication, shipyards, salvage, construction and other general purpose uses.





Ergonomics

Precisely balanced, long lasting hand torches

- **Tip mixing system**

The triple-seat nozzle mixing system assures greater safety and reduces the risk of flashback and backfire.

- **Precisely balanced**

Each torch is designed to provide ease of use in any application.

- **Heavy ribbed round handle**

Provides good ventilation and a sure handed grip on the torch.

- **Internal tip nut**

Protects threads in torch head.

- **Easy grip gas valves**

Allows gloved hands to quickly and accurately set preheat flame.

SILVER-CUT Series

- **Lightweight and compact**, well balanced hand cutting torch
- **Chrome plated tubes**
- **Triangular tube configuration**, for extra strengths



SILVER-CUT K250

Torch length	495 mm
Weight	1.0 kg
Cutting capacity	Max. 250 mm
Torch head angle	90°
Fuel gas type	Any medium pressure fuel gas

Types	Connection	Stock #
SILVER-CUT K250	G3/8 RH-LH	80496
SILVER-CUT K250 9/16	9/16" RH-LH	80495

MK Series

- **Expertly crafted in Japan**
- **Robust**, heavy duty hand cutting torch
- **Three stainless steel tubes**, provides strengths and durability while keeping gases separated to mix safely in the cutting nozzle
- Cutting oxygen **lever with lock function**. (excl. MK-36)
- **Die forged head**, increased strengths and service life

MK-150



MK-150

Torch length	466 mm
Weight	0.9 kg
Cutting capacity	Max. 150 mm
Torch head angle	90°
Torch connection	G3/8 RH-LH
Fuel gas type	Any medium pressure fuel gas

Types	Stock #
MK-150	80497

MK-250



MK-250

Torch length	525 mm (standard, 90° head)
Weight	1.5 kg
Cutting capacity	Max. 250 mm
Fuel gas type	Any medium pressure fuel gas

Types	Torch angle	Connection	Stock #
MK-250-75D	75°	G1/4, G3/8	80503
MK-250-90D	90°	G3/8, G3/8	80504
MK-250-180D	180°	G3/8, G3/8	DA222815

MK-300



MK-300

Torch lengths	661 mm (standard, 90° head)
Weight	1.55 kg
Cutting capacity	Max. 300 mm
Torch head angle	75° and 90°
Torch connection	G1/4RH, G3/8LH
Fuel gas type	Any medium pressure fuel gas

Types	Torch angle	Stock #
MK-300-75D	75°	80507
MK-300-90D	90°	80508

MK-36



MK-36

Torch length	915mm
Weight	1.5 kg
Cutting capacity	Max. 200 mm
Torch head angle	75° and 90°
Torch connection	G3/8 RH-LH
Fuel gas type	Any medium pressure fuel gas

Types	Torch angle	Stock #
MK-36 75D	75°	DA212825
MK-36 90D	90°	-

Hand Torch Accessory

■ Dual roller guide

Enables stable cutting. Equipped with two smooth rollers and a tip holder.

	Stock #
Dual roller guide	80515



■ Circle bar with center pin

Attachment to dual roller guide, for circular cutting using any hand torch. Cutting diameter adjustable up to Ø 550 mm.

	Stock #
Circle bar with center pin	80516





KOIKE CUTTING NOZZLES

The Trademark for High Quality Cutting

Features and Benefits

- **Sharp, high quality cuts**
- **Small kerf**
- **Limited upper edge melt**
- **Limited upper edge slag**
- **Limited under slag**
- **Steady and safe cutting operation**
- **Cutting with small gas consumption**
- **Variety of selections**
 - * Standard nozzle
 - * Divergent high-speed nozzle
 - * Out-mixing heavy duty nozzle
 - * Speciality nozzles
- **Excellent quality management**

All KOIKE 100 Series cutting tips are designed to mix the fuel and the oxygen used for preheating inside the cutting-tip. This is recognized as one of the safest methods. The KOIKE D7 cutting tips are one of the most technically advanced cutting tips available, providing safety and accuracy while saving money in time and gas costs. Our high speed D7 Series cutting tips with the divergent tip increases cutting speed up to 28% over standard tips and gas consumption is reduced to 26%. A stainless steel liner helps them to last up to 5 times longer.



Strong cutting oxygen stream from a divergent nozzle: Photo taken from KOIKE in-house performance test. Nozzle tip at 275 mm above the plate, nozzle 106-D7#0

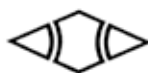

The trademark of quality

All genuine KOIKE cutting nozzles are marked with KOIKE Japan logo.

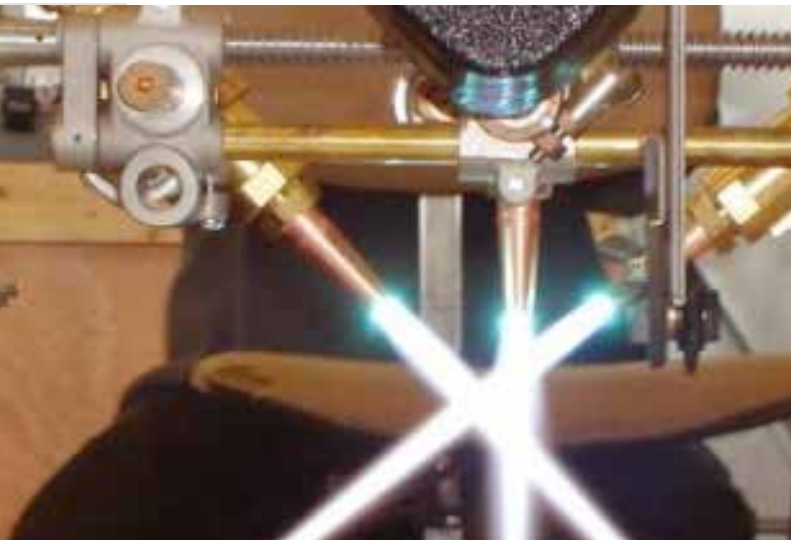

Designed for High Quality Cutting

Commitment to research, design, manufacturing and inspection

- **Design**
 Each KOIKE cutting nozzle is designed for economic cutting and to provide the highest cutting accuracy.
- **Quality**
 Made in Japan at KOIKE's top level production facility and quality management system, the KOIKE nozzles ensure each cutting nozzle to be of the KOIKE quality.
- **Safety**
 All 100 series cutting nozzles are designed to help prevent damaging flashbacks and backfires into the torch.

KOIKE Divergent Nozzle

- **State-of-the-Art design**
 The cutting oxygen outlet of KOIKE High-speed nozzles forms a divergent shape, designed through a high technical calculation to accelerate cutting oxygen flow up to 2 times faster the speed of sound.
- **Productivity**
 Cutting speed is increased by up to 28% over standard nozzles.
- **Cost efficiency**
 Due to faster cutting speeds, gas consumption is reduced to 26%. (Compared to non-divergent nozzle).
- **Durability**
 Stainless steel insert at the nozzle tip improves life time of the nozzle and ensures long lasting performance.
- **100% ignition tested**
 All divergent nozzles are manually tested prior to packaging, ensuring every nozzle to perform as designed. Carbon adherence may remain on a new nozzle, but it is the sign of our quality.

Designed to perform

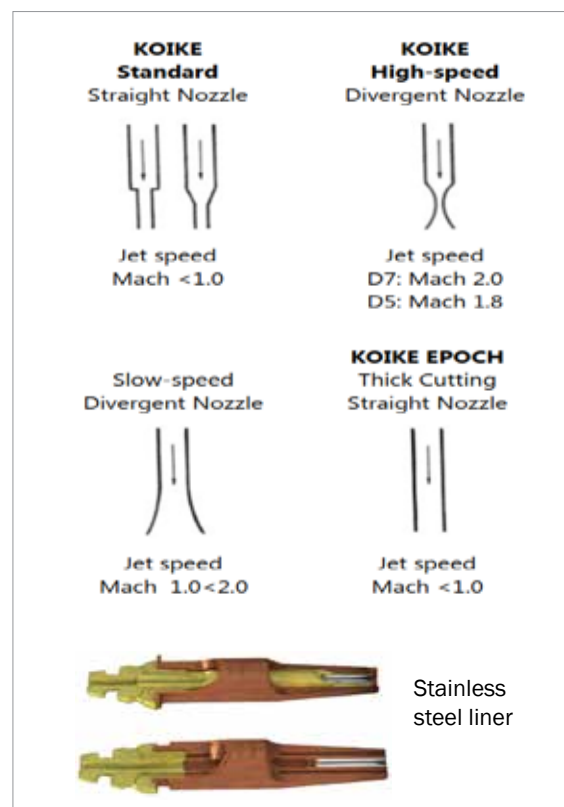

102-HC



Standard nozzle

Acetylene

Stock #	Thickness (mm)	Tip #	Pressure (bar)		Consumption (NI/h)			Cutting speed (mm/min)
			Oxygen	Fuel Gas	Cutting O ²	Preheat O ²	Fuel gas	
80011	<5	00	1.5	0.2	690	410	370	>660
80012	5-10	0	2.0	0.2	1200	410	370	660-550
80013	10-15	1	2.5	0.2	2100	480	430	550-490
80014	15-30	2	3.0	0.2	3400	480	430	490-400
80015	30-40	3	3.0	0.2	4300	480	430	400-350
80016	40-50	4	3.5	0.3	6500	550	500	350-320
80017	50-100	5	4.0	0.3	11000	690	630	320-200
80018	100-150	6	4.0	0.4	15000	770	700	200-150
80019	150-250	7	4.5	0.4	22000	1060	960	150-80
80051	250-300	8	4.5	0.4	28000	1060	960	80-45

102-D5



High-speed nozzle (5 bar)

Acetylene

Stock #	Thickness (mm)	Tip #	Pressure (bar)		Consumption (NI/h)			Cutting speed (mm/min)
			Oxygen	Fuel Gas	Cutting O ²	Preheat O ²	Fuel gas	
80201	<5	00	5.0	0.2	850	520	470	>700
80202	5-10	0	5.0	0.2	1600	520	470	700-625
80203	10-15	1	5.0	0.2	2400	600	550	625-550
80204	15-30	2	5.0	0.2	3600	600	550	550-475
80205	30-40	3	5.0	0.2	4800	600	550	475-425
80206	40-50	4	5.0	0.2	5600	750	680	425-350
80207	50-100	5	5.0	0.3	8800	860	780	350-250
80208	100-150	6	5.0	0.3	13500	950	860	250-175
80209	150-250	7	5.0	0.3	24000	1330	1210	175-90
80210	250-300	8	5.0	0.4	31000	1600	1450	90-600

102-D7



High-speed nozzle (7 bar)

Acetylene

Stock #	Thickness (mm)	Tip #	Pressure (bar)		Consumption (NI/h)			Cutting speed (mm/min)
			Oxygen	Fuel Gas	Cutting O ²	Preheat O ²	Fuel gas	
80221	<5	00	7.0	0.2	750	520	470	>750
80222	5-10	0	7.0	0.2	1100	520	470	750-680
80223	10-15	1	7.0	0.2	2500	600	550	680-600
80224	15-30	2	7.0	0.2	3800	600	550	600-500
80225	30-40	3	7.0	0.2	5400	600	550	500-450
80226	40-50	4	7.0	0.2	7300	750	680	450-400
80227	50-100	5	7.0	0.3	10000	860	780	400-260
80228	100-150	6	7.0	0.3	14000	950	860	260-180
80229	150-250	7	7.0	0.3	22000	1330	1210	180-100
80230	250-300	8	7.0	0.4	35000	1600	1450	100-70

Cutting nozzles

103-D7



High-speed nozzle (7 bar)

Ethylene

Stock #	Thickness (mm)	Tip #	Pressure (bar)		Consumption (NI/h)			Cutting speed (mm/min)
			Oxygen	Fuel Gas	Cutting O ²	Preheat O ²	Fuel gas	
80179	5	00	7.0	0.2	750	800	460	>750
80180	5-10	0	7.0	0.2	1100	800	460	750-680
80181	10-15	1	7.0	0.2	2500	800	460	680-600
80182	15-30	2	7.0	0.25	3800	900	500	600-500
80183	30-40	3	7.0	0.25	5400	900	500	500-450
80184	40-50	4	7.0	0.35	7300	1200	660	450-400
80185	50-100	5	7.0	0.35	10000	1200	660	400-260
80186	100-150	6	7.0	0.35	14000	2200	1280	260-180
80187	150-250	7	7.0	0.35	22000	2200	1280	180-100
80188	250-300	8	7.0	0.35	35000	2200	1280	100-70

107



Standard nozzle

Natural gas

Stock #	Thickness (mm)	Tip #	Pressure (bar)		Consumption (NI/h)			Cutting speed (mm/min)
			Oxygen	Fuel Gas	Cutting O ²	Preheat O ²	Fuel gas	
80061	5	00	1.5	0.15	690	1000	600	>660
80062	5-10	0	2.0	0.15	1200	1000	600	660-550
80063	10-15	1	2.5	0.15	2100	1200	700	550-490
80064	15-30	2	3.0	0.15	3400	1200	700	490-400
80065	30-40	3	3.0	0.15	4300	1350	800	400-350
80066	40-50	4	3.5	0.15	6500	1350	800	350-320
80067	50-100	5	4.0	0.15	11000	1700	1000	320-200
80068	100-150	6	4.0	0.15	15000	1700	1000	200-150

107-D7



High-speed nozzle (7 bar)

Natural gas

Stock #	Thickness (mm)	Tip #	Pressure (bar)		Consumption (NI/h)			Cutting speed (mm/min)
			Oxygen	Fuel Gas	Cutting O ²	Preheat O ²	Fuel gas	
80282	5-10	0	7.0	0.15	1100	1350	800	750-680
80283	10-15	1	7.0	0.15	2500	1500	900	680-600
80284	15-30	2	7.0	0.15	3800	1500	900	600-500
80285	30-40	3	7.0	0.15	5400	1700	1000	500-450
80286	40-50	4	7.0	0.15	7300	1700	1000	450-400
80287	50-100	5	7.0	0.15	10000	1850	1100	400-260
80288	100-150	6	7.0	0.2	14000	2200	1300	260-180

106-HC



Standard nozzle

Propane

Stock #	Thickness (mm)	Tip #	Pressure (bar)		Consumption (NI/h)			Cutting speed (mm/min)
			Oxygen	Fuel Gas	Cutting O ²	Preheat O ²	Fuel gas	
80041	5	00	1.5	0.2	690	1180	310	>660
80042	5-10	0	2.0	0.2	1200	1180	310	660-550
80043	10-15	1	2.5	0.2	2100	1180	310	550-490
80044	15-30	2	3.0	0.25	3400	1370	360	490-400
80045	30-40	3	3.0	0.25	4300	1370	360	400-350
80046	40-50	4	3.5	0.3	6500	1860	490	350-320
80047	50-100	5	4.0	0.3	11000	1860	490	320-200
80048	100-150	6	4.0	0.3	15000	3040	800	200-150
80049	150-250	7	4.5	0.4	22000	3720	980	150-80
80050	250-300	8	4.5	0.4	28000	3720	980	80-45

106-D5



High-speed nozzle

Propane

Stock #	Thickness (mm)	Tip #	Pressure (bar)		Consumption (NI/h)			Cutting speed (mm/min)
			Oxygen	Fuel Gas	Cutting O ²	Preheat O ²	Fuel gas	
80191	<5	00	5.0	0.2	850	1180	310	>700
80192	5-10	0	5.0	0.2	1600	1180	310	700-625
80193	10-15	1	5.0	0.2	2400	1180	310	625-550
80194	15-30	2	5.0	0.25	3600	1370	360	550-475
80195	30-40	3	5.0	0.25	4800	1370	360	475-425
80196	40-50	4	5.0	0.3	5600	1860	490	425-350
80197	50-100	5	5.0	0.3	8800	1860	490	350-250
80198	100-150	6	5.0	0.3	13500	3040	800	250-175
80199	150-250	7	5.0	0.4	24000	3720	980	175-90
80200	250-300	8	5.0	0.4	31000	3720	980	90-60

106-D7



High-speed nozzle

Propane

Stock #	Thickness (mm)	Tip #	Pressure (bar)		Consumption (NI/h)			Cutting speed (mm/min)
			Oxygen	Fuel Gas	Cutting O ²	Preheat O ²	Fuel gas	
80241	<5	00	7.0	0.2	750	1180	310	>750
80242	5-10	0	7.0	0.2	1100	1180	310	750-680
80243	10-15	1	7.0	0.2	2500	1180	310	680-600
80244	15-30	2	7.0	0.25	3800	1370	360	600-500
80245	30-40	3	7.0	0.25	5400	1370	360	500-450
80246	40-50	4	7.0	0.3	7300	1860	490	450-400
80247	50-100	5	7.0	0.3	10000	1860	490	400-260
80248	100-150	6	7.0	0.3	14000	3040	800	260-180
80249	150-250	7	7.0	0.4	22000	3720	980	180-100
80250	250-300	8	7.0	0.4	35000	3720	980	100-70

Cutting nozzles

106-M7



High-speed heavy preheat nozzle

Propane

Stock #	Thickness (mm)	Tip #	Pressure (bar)		Consumption (NI/h)			Cutting speed (mm/min)
			Oxygen	Fuel Gas	Cutting O ²	Preheat O ²	Fuel gas	
80151	5	00	7.0	0.2	750	1710	450	>750
80152	5-10	0	7.0	0.2	1100	1710	450	750-680
80153	10-15	1	7.0	0.2	2500	1710	450	680-600
80154	15-30	2	7.0	0.2	3800	2470	650	600-500
80155	30-40	3	7.0	0.2	5400	2470	650	500-450
80156	40-50	4	7.0	0.2	7300	2470	650	450-400
80157	50-100	5	7.0	0.25	10000	2890	760	400-260
80158	100-150	6	7.0	0.25	14000	3570	940	260-180
80159	150-250	7	7.0	0.3	22000	3990	1050	180-100
80160	250-300	8	7.0	0.3	35000	3990	1050	100-70

EPOCH-300



Thick plate cutting nozzle

Propane

Stock #	Thick- ness (mm)	Pressure (bar)			Consumption (NI/h)			Cutting speed mm/min	Kerf (mm)
		Cuttung O ²	Preheat O ²	Fuel Gas	Cutting O ²	Preheat O ²	Fuel gas		
80397	100	4	0.5-0.6	0.3-0.4	27	3.3-4.0	2.3-2.7	250-290	5.5-7.0
	200	4.5	0.5-0.6	0.3-0.4	30	3.3-4.0	2.3-2.7	170-190	6.0-8.0
	300	5	0.6-0.7	0.4-0.5	32	4.0-4.8	2.7-3.1	130-150	7.0-9.0

EPOCH-600



Thick plate cutting nozzle

Propane

Stock #	Thick- ness (mm)	Pressure (bar)			Consumption (NI/h)			Cutting speed mm/min	Kerf (mm)
		Cuttung O ²	Preheat O ²	Fuel Gas	Cutting O ²	Preheat O ²	Fuel gas		
80398	300	5	0.6-0.7	0.4-0.5	60	4.0-4.8	2.7-3.1	130-150	8.0-12.0
	400	6	0.7-1.0	0.5-0.6	70	4.8-7.0	3.1-3.4	80-90	10.0-13.0
	500	7	0.7-1.0	0.5-0.6	80	4.8-7.0	3.1-3.4	60-70	11.0-14.0
	600	10	0.7-1.0	0.5-0.6	110	4.8-7.0	3.1-3.4	50-60	12.0-15.0

CNC cutting machines



KOIKE is the world's leading manufacturer of the most extensive cutting product line for oxy-fuel, plasma, and laser cutting machines.

Request your catalogue via:
info@koike-europe.com



EMEA Sales and Service Offices

FRANCE

KOIKE France S.A.R.L.
ZAC de la Vallee de L'aunelle
RN Cellules C1 à C4
59144 Wargnies-Le-Grand
Office: +33 327304343

GERMANY

KOIKE EUROPE B.V. Germany Branch Office
Im Löchel 2
35423 Lich-Eberstadt
Office: +49 6004916930

ITALY

KOIKE ITALIA Srl
Via Papa Giovanni XXIII, n 45
20053 - Rodano (Milano)
Office: +39 0295328717

UAE

KOIKE MIDDLE EAST FZE
SAIF Zone Sharjah - UAE
P.O. Box 122978
Office: +971 561177615

THE NETHERLANDS

KOIKE EUROPE B.V.
Grote Tocht 19
1507 CG Zaandam

T +31 (0)75 612 72 27

F +31 (0)75 612 34 61

info@koike-europe.com
www.koike-europe.com